

TABLE OF CONTENTS

ENGLISH.....	1-8
BULGARIAN.....	9-16
ITALIAN.....	17-24
HUNGARIAN.....	25-32
GERMAN.....	33-40
SPANISH.....	41-48
FRENCH.....	49-56
CROATIAN.....	57-64
PORTUGUESE.....	65-72
GREEK	73-80
POLISH	81-88
ROMANIAN.....	89-96
CZECH.....	97-104

INSTALLATION INSTRUCTION HIGHBAY SENSOR



5 YEARS
WARRANTY*

INTRODUCTION & WARRANTY

Thank you for selecting and buying V-TAC product. V-TAC will serve you the best. Please read these instructions carefully before starting the installation and keep this manual handy for future reference. If you have any another query, please contact our dealer or local vendor from whom you have purchased the product. They are trained and ready to serve you at the best. The warranty is valid for 5 years from the date of purchase. The warranty does not apply to damage caused by incorrect installation or abnormal wear and tear. The company gives no warranty against damage to any surface due to incorrect removal and installation of the product. This product is warranted for manufacturing defects only.

WARNING

1. Please make sure to turn off the power before starting the installation.
2. Installation must be performed by a certified person.



This marking indicates that this product should not be disposed of with other household wastes.



Caution, risk of electric shock.

PRODUCT FEATURES

1. Operating voltage 100/277V AC,50/60Hz
2. Microwave antenna mounting height is 15m Max, suitable to install in most warehouses.
3. Supports high-sensitivity and low-sensitivity modes (for metal ceilings, metal reflector mounting environments) & work with 1-10V dimmable LED driver, easy to achieve 2-step or 3-step dimming function.
4. Compatible with V-TAC Highbay Models VT-9-151 and VT-9-200

PARAMETERS

Input	Operating Voltage Range	108-305V AC, 50Hz/60Hz
	DC Input Voltage	N/A
	Rated Voltage	100/277V AC, 50Hz/60Hz
	No-load Power	N/A
	Stand-by Power	<1W
Output	Surge Test	L-N: 1kV
	Working Mode	ON/OFF function, 1-10V step dimming
	Type of Load	Inductive or resistive Load
	Load Capacity	100VAC: 4A; 277VAC: 3A
	Current of Load	N/A
Dim Interface	Max. Surge Capacity	50A (50% Ipeak, twidth =500uS, 230Vac full load, cold start);
		80A (50% Ipeak, twidth =200uS, 230Vac, full load, cold start)
	1-10V Dimming	< 50mA (Non-constant source) 10%(1.4-1.6V), 20%(1.9-2.1V), 30%(2.9-3.1V), 50% (4.9-5.1V)
	Synchronous Control	N/A
Sensor Parameters	High Low-level	N/A
	PWM Control	N/A
	Operating Frequency	5.8 GHz ±75 MHz, ISM Band.
	Transmitting power	0.5mW Max.
Operating Environment	Hold time	5s/30s/1min/3min/5min/10min/20min/30min
	Stand-by DIM Level	10%/20%/30%/50%
	Stand-by Period	0s/10s/1min/3min/5min/10min/30min/+∞
	Detection Area	25%/50%/75%/100%
	Daylight Sensor	5lux/15lux/30lux/50lux/100lux/150lux/Disable (Ambient light diffusion)
	Mounting Height	15m Max
	Detecting Angle	360°(ceiling mounting)
	Operating Temperature	-35 to +55
Others	Storage Temperature	Temperature:-40 to +80; Humidity:10%-95% (non-condensing)
	Wiring	H05RR-F,5*18AWG exposed line length: 810-830mm
	Wiring Color	Sheath: blue, brown, red, purple, gray
	IP Rating	IP65
	Protection Class	Class II
	Installation	Independent
	Dimension	(ΦxH)72*59mm
Lifetime	50,000h @ Ta Full load	

Note

1. "N/A" means not available.
2. Detection area is effected on volume of motion object and motion speed. The detection area is tested by a 165cm height person and walking speed is 0.5m/s.

FUNCTIONS

1. ON/OFF Function (stand-by period set to "0"s)

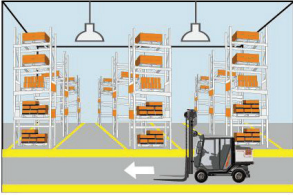

1. With sufficient ambient light, the light will not switch ON even if motion signal is present.

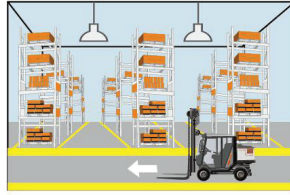

2. With sufficient ambient light, the sensor switches on the light when motion is detected.

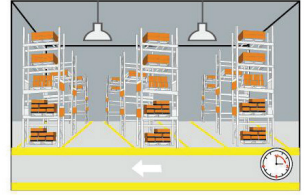

3. After elapse of hold time, the sensor switches off the light when no motion is detected.

2) 2-step dimming function (stand-by period be set to "+∞")

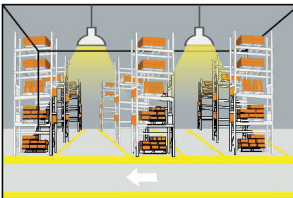

1. If there is no motion detected, the light will remain at a low level light all the time.

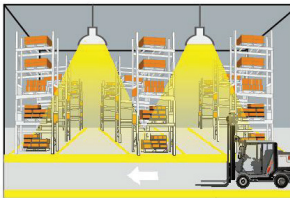

2. When motion is detected, the sensor will switch on the light to 100% brightness.

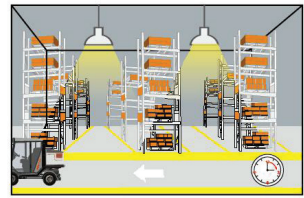

3. After elapse of hold time, the sensor dims the light at the present low light level if no motion is detected.

3) 3-step dimming function (stand-by period be set to "10s/1min/3min/5min/10min/30min")

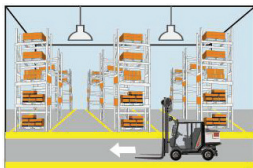

1. With sufficient ambient light, the light will not be switched on even if motion signal is present.

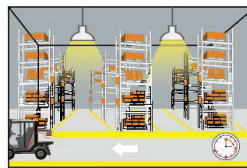

3. After elapse of hold time, the sensor dims the light at low light level if no new motion is detected.

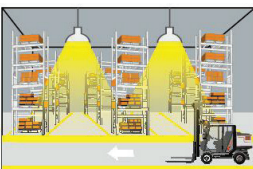

2. With sufficient ambient light, the sensor switches on the light when motion is detected.

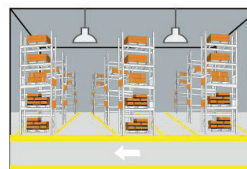

4. After elapse of standby period, the sensor switches off the light if no motion is detected in the detection zone.

DIMENSIONS DIAGRAM

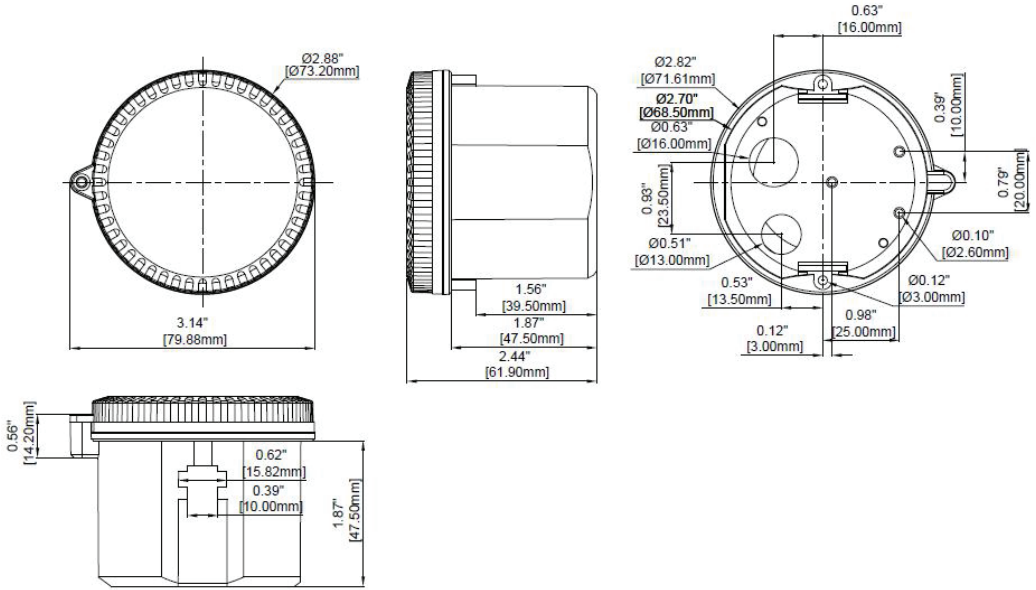

WIRING DIAGRAM

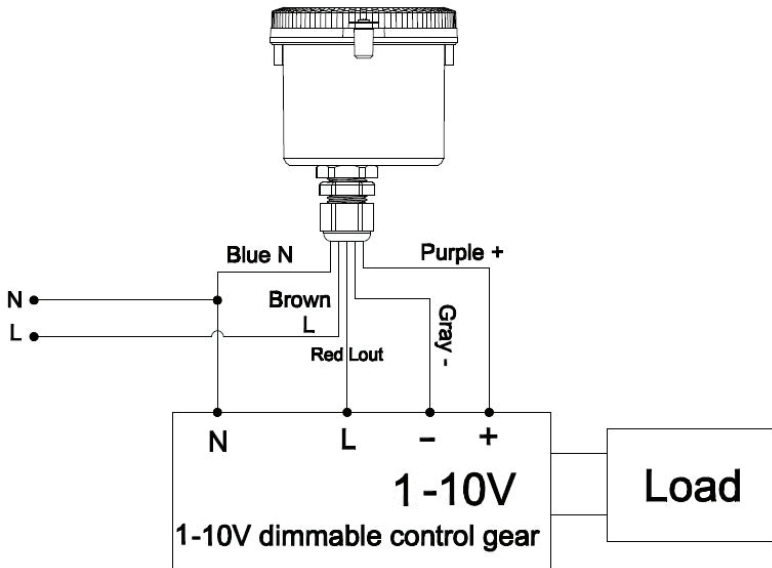

INSTALLATION DIAGRAM

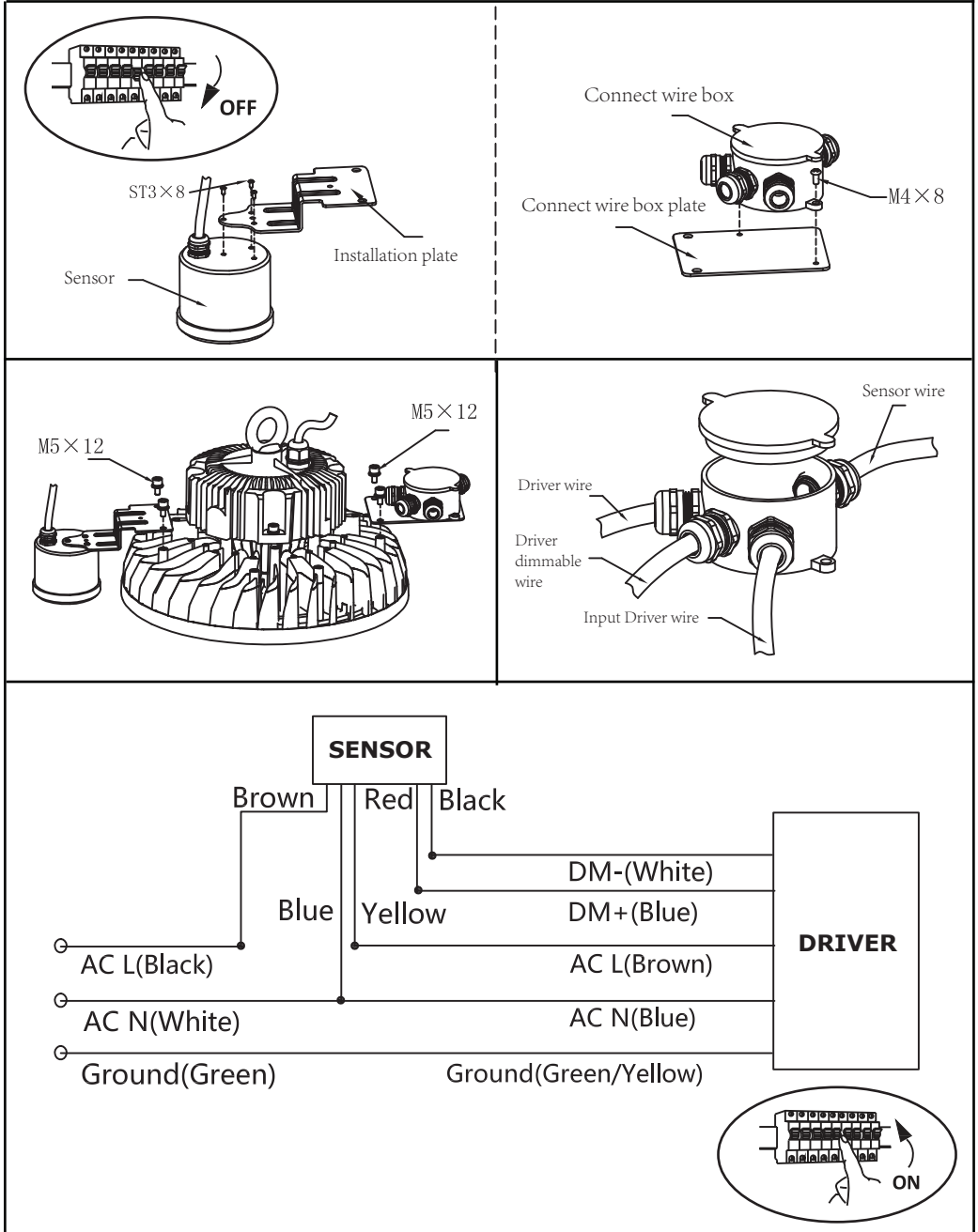

FUNCTION DIAGRAM

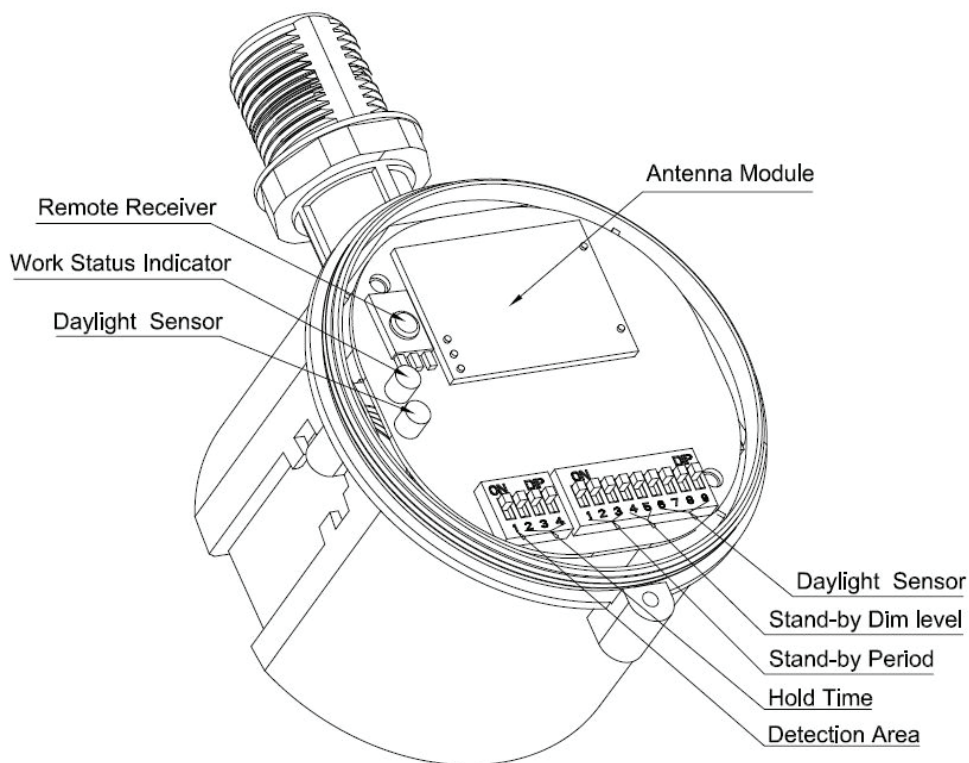

CONTROLS

(HOLD TIME)

	2	3	4	
I	ON	ON	ON	5s
II	-	ON	ON	30s
III	ON	-	ON	1min
IV	-	-	ON	3min
V	ON	ON	-	20min
VI	-	-	-	30min

(STAND-BY PERIOD)

	1	2	3	
I	ON	ON	ON	0s
II	-	ON	ON	1min
III	ON	-	ON	3min
IV	-	-	ON	10min
V	ON	ON	-	30min
VI	-	-	-	+∞

(STAND-BY DIM LEVEL)

	4	5	%	1-10V
I	ON	ON	10%	1.4-1.6V
II	ON	-	20%	1.9-2.1V
III	-	ON	30%	2.9-3.1V
IV		-	50%	4.9-5.1V

(DAYLIGHT SENSOR)

	6	7	8	9	
I	ON	ON	ON	ON	5Lux
II	-	ON	ON	ON	15Lux
III	ON	-	ON	ON	30Lux
IV	-	-	ON	ON	50Lux
V	ON	ON	-	ON	100Lux
VI	ON	ON	ON	-	150Lux
VII	-	-	-	-	Disable*

(DETECTION AREA)

	1	
I	ON	100%
II	-	50%

CEILING MOUNTING DIAGRAM

Ceiling mounted
height: 3m
Sensitivity:
100%/75%/50%/25%

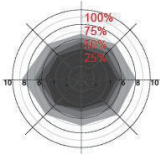

Normal moving
(Speed:1m/s)

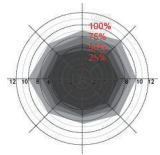

Slow moving
(Speed 0.3m/s)

Ceiling mounted
height: 6m
Sensitivity:
100%/75%/50%/25%

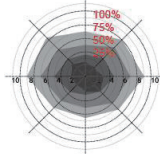

Normal moving
(Speed:1m/s)

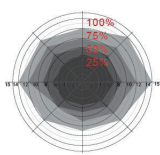

Slow moving
(Speed: 0.3m/s)

Ceiling mounted
height: 9m
Sensitivity:
100%/75%/50%/25%

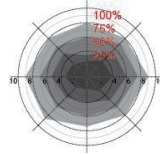

Normal moving
(Speed:1m/s)

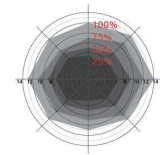

Slow moving
(Speed: 0.3m/s)

Ceiling mounted
height: 12m
Sensitivity:
100%/75%/50%

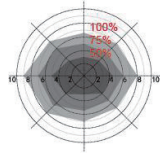

Normal moving
(Speed:1m/s)

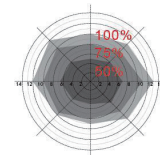

Slow moving
(Speed: 0.3m/s)

Ceiling mounted
height: 15m
Sensitivity:
100%/75%

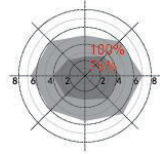

Normal moving
(Speed:1m/s)

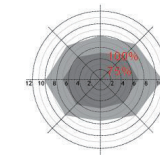

Slow moving
(Speed: 0.3m/s)

*Only 100%/75%/50% detection sensitivity is workable when installed at 10m & 15m mounting height. 25% sensitivity is not able to detect motion signal.

INITIALIZATION

1. On/Off function /3-step dimming function:

After power on, the sensor automatically turns on light at 100% brightness. After 10sec, it turns off the light. During the initialization, the sensor is not able to detect movement.

2. 2-step dimming function:

After power on, the sensor automatically turns on light at 100% brightness. After 10sec, it dims the light to a low light level (set by stand-by dim level). During the initialization, the sensor is not able to detect movement.

FACTORY SETTING

Detection area: 100%, Hold Time: 5S, Stand-by Period: 0s, Stand-by dim level: 10%, Daylight Sensor: Disable

APPLICATION NOTICE

- 1) The sensor should be installed by a professional electrician. Please turn off the power before installing, wiring, changing the setting of the DIP switch.
- 2) The sensor which installed in the plastic and glass lampshade will reduce the sensitivity. For every 3mm increase in thickness, the sensitivity will be reduced by 20%.
- 3) The dimming performance could be different from different 1-10v drivers.
- 4) The light sensitivity threshold is in a sunny environment, no shadow and ambient light diffuse reflection. Ambient lux level could be different in different environment, weather, climate, time-of-day and season.
- 5) The parameters of the sensor may need to be reconfigured in different installation environments.
- 6) This sensor is for indoor use only. It will affect the waterproof effect for outdoor use. Wind, rain, and moving objects around will cause false triggering.
- 7) The distance between any inductive sensors should be greater than 3m.
- 8) Do not place the sensor close to high-density objects such as metal, glass, concrete walls, etc, false triggering could happen. When the sensor is installed in a metal lamp, metal reflective surface, or a narrow enclosed environment, the microwave will be reflected repeatedly and cause false triggering. Please reduce the sensitivity or contact the manufacturer for technical support.
- 9) Please ensure that there are no moving signals around the sensor, such as fan, DC motor, sewer pipe, air outlet, etc., the sensor may generate false trigger.
- 10) You are advised to test 5 samples before mass application of sensor in a new lighting project.
- 11) Due to continuous improvement, the contents of this instruction could be changed without prior notice.

ИНСТРУКЦИИ ЗА ИНСТАЛАЦИЯ HIGHBAY SENSOR



5 YEARS
WARRANTY

ВЪВЕДЕНИЕ И ГАРАНЦИЯ

Благодарим ви, че избрахте и закупихте продукт на Ви-Тек (V-TAC). Ви-Тек (V-TAC) ще ви послужи по най-добрия възможен начин. Моля прочетете тези инструкции внимателно преди инсталация и съхранявайте ръководството за бъдещи справки. Ако имате други въпроси, моля свържете се с нашия дилър или с местния търговец, от който сте закупили продукта. Те са обучени и са готови да ви послужат по най-добрия начин. Гаранцията е валидна за период от 5 години след датата на закупуване. Гаранцията не се прилага по отношение на щети, причинени поради неправилен монтаж или необичайно износване. Дружеството не предоставя гаранция срещу щети по каквато и да е повърхност поради неправилното отстраняване и монтаж на продукта.

ВНИМАНИЕ

1. Моля прочетете настоящите инструкции и изключете захранването, преди да започнете монтажа.
2. Инсталация само от сертифициран електротехник



Тази маркировка указва, че този продукт не трябва да бъде депониран заедно с други битови отпадъци.



Внимание, риск от електрически шок.

ПРОДУКТОВИ ХАРАКТЕРИСТИКИ

1. Експлоатационно напрежение 100/277V AC, 50/60Hz
2. Височината на монтаж на микровълновата антена е максимум 15 m, подходяща за инсталация в повечето складове.
3. Поддържа режими за висока чувствителност и ниска чувствителност (за метални тавани, метални рефлекторни монтажни среди) и работа с 1-10V светодиоден драйвър за затъмнение, лесна за достигане 2-степенна или 3-степенна функция за затъмнение.
4. Съвместим с модели „Highbay“ на Ви-Тек VT-9-151 и VT-9-200

ПАРАМЕТРИ

Input	Operating Voltage Range	108-305V AC, 50Hz/60Hz
	DC Input Voltage	N/A
	Rated Voltage	100/277V AC, 50Hz/60Hz
	No-load Power	N/A
	Stand-by Power	<1W
Output	Surge Test	L-N: 1kV
	Working Mode	ON/OFF function, 1-10V step dimming
	Type of Load	Inductive or resistive Load
	Load Capacity	100VAC: 4A; 277VAC: 3A
	Current of Load	N/A
Dim Interface	Max. Surge Capacity	50A (50% Ipeak, twidth =500uS, 230Vac full load, cold start);
		80A (50% Ipeak, twidth =200uS, 230Vac, full load, cold start)
		< 50mA (Non-constant source)
	1-10V Dimming	10%(1.4-1.6V), 20%(1.9-2.1V), 30%(2.9-3.1V), 50% (4.9-5.1V)
	Synchronous Control	N/A
Sensor Parameters	High Low-level	N/A
	PWM Control	N/A
	Operating Frequency	5.8 GHz ±75 MHz, ISM Band.
	Transmitting power	0.5mW Max.
	Hold time	5s/30s/1min/3min/5min/10min/20min/30min
Operating Environment	Stand-by DIM Level	10%/20%/30%/50%
	Stand-by Period	0s/10s/1min/3min/5min/10min/30min/+∞
	Detection Area	25%/50%/75%/100%
	Daylight Sensor	5lux/15lux/30lux/50lux/100lux/150lux/Disable (Ambient light diffusion)
	Mounting Height	15m Max
	Detecting Angle	360°(ceiling mounting)
	Operating Temperature	-35 to +55
Others	Storage Temperature	Temperature:-40 to +80; Humidity:10%-95% (non-condensing)
	Wiring	H05RR-F,5*18AWG exposed line length: 810-830mm
	Wiring Color	Sheath: blue, brown, red, purple, gray
	IP Rating	IP65
	Protection Class	Class II
	Installation	Independent
	Dimension	(ΦxH)72*59mm
Lifetime	50,000h @ Ta Full load	

Забележка

1. "N/A" означава, че няма наличност.
2. Зоната на засичане зависи от обема на движещия се обект и на скоростта на движение. Зоната за засичане се изпитва чрез човек с височина 165 см. и скорост на движение 0.5 m/s.

ФУНКЦИИ

1) Функция за ВКЛЮЧВАНЕ/ИЗКЛЮЧВАНЕ (за период на престой е зададен "0")

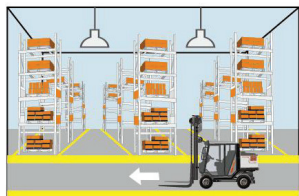

1. При достатъчна светлина от околната среда, светлината няма да бъде ВКЛЮЧВАНА дори ако има наличен сигнал за движение.

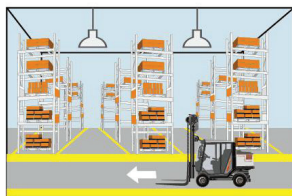

2. При достатъчна светлина от околната среда, сензорът включва светлината при установяване на движение.

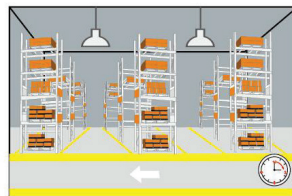

3. След изтичането на времето за изчакване, сензорът изключва светлината когато не бъде засечено движение.

2) 2-степенна функция за затъмняване (периодът на престой е зададен за "+∞")

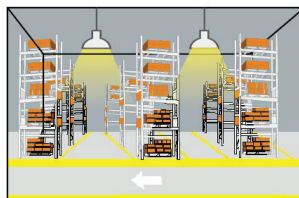

1. Ако не бъде установено движение, светлината остава включена на ниско равнище на осветление през цялото време.

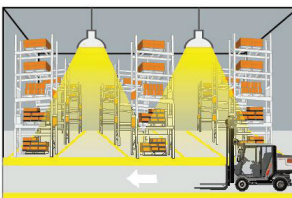

2. Ако не бъде установено движение, светлината остава включена на ниско равнище на осветление през цялото време.

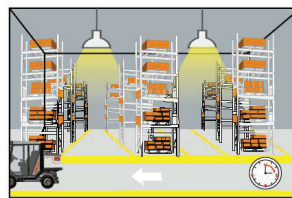

3. След изтичането на времето за изчакване, сензорът затъмнява светлината до текущото ниско равнище на светлината, в случай че не бъде засечено движение.

3) 3-степенна функция за затъмняване (периодът на престой е зададен за "10 секунди / 1 минута / 3 минути / 5 минути / 10 минути / 30 минути")

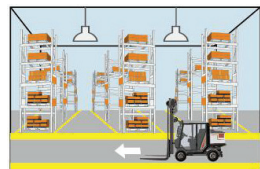

1. При достатъчна светлина от околната среда, светлината няма да бъде включвана дори ако има наличен сигнал за движение.

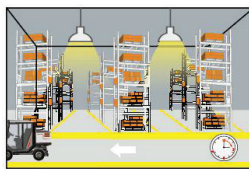

3. След изтичането на времето за престой, сензорът затъмнява светлината до ниското равнище на светлина, ако не бъде засечено ново движение.

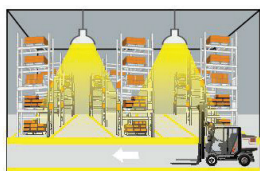

2. При достатъчна светлина от околната среда, сензорът включва светлината при установяване на движение.

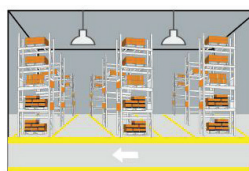

4. След изтичането на времето за изчакване, сензорът изключва светлината, ако не бъде засечено движение в зоната за засичане.

ДИАГРАМА ЗА РАЗМЕРИ

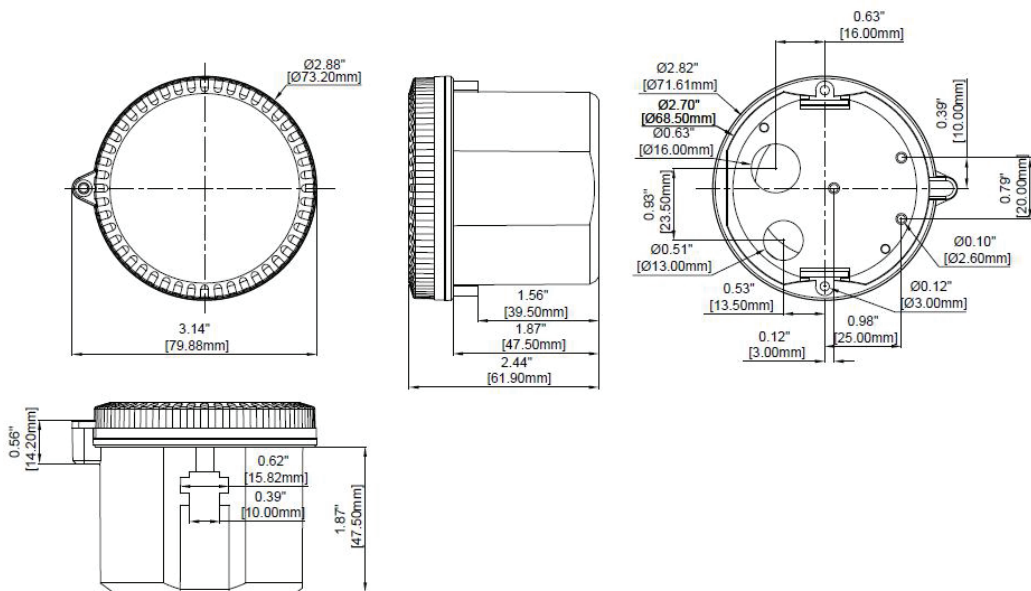

ДИАГРАМА ЗА ОКАБЕЛЯВАНЕ

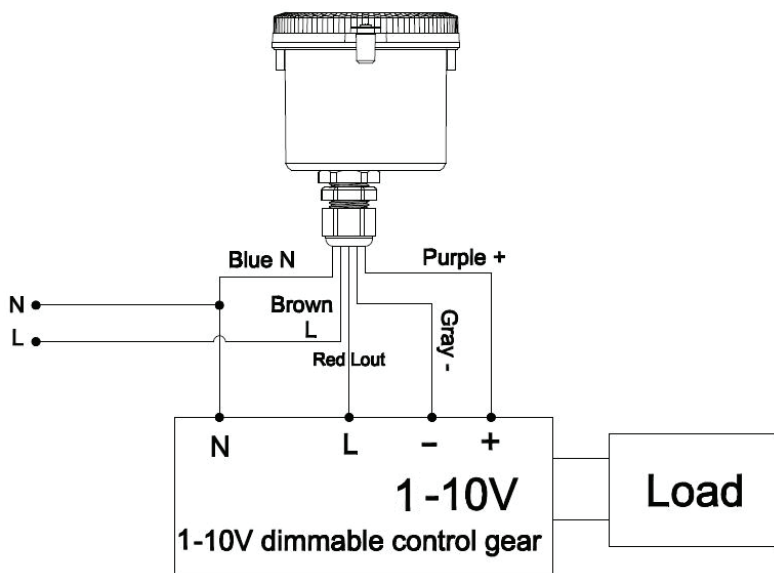

ДИАГРАМА ЗА ИНСТАЛАЦИЯ

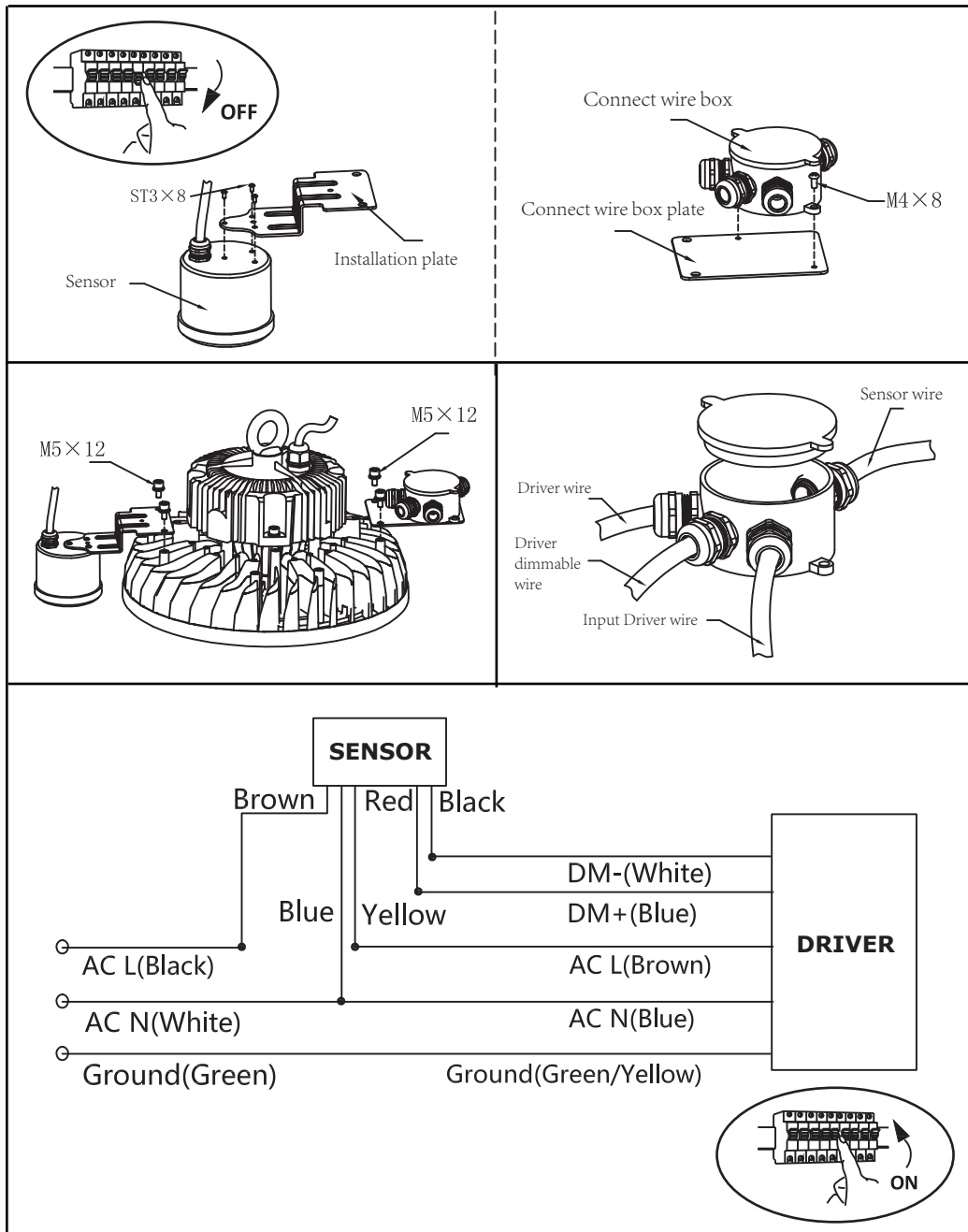

ДИАГРАМА ЗА ФУНКЦИЯ

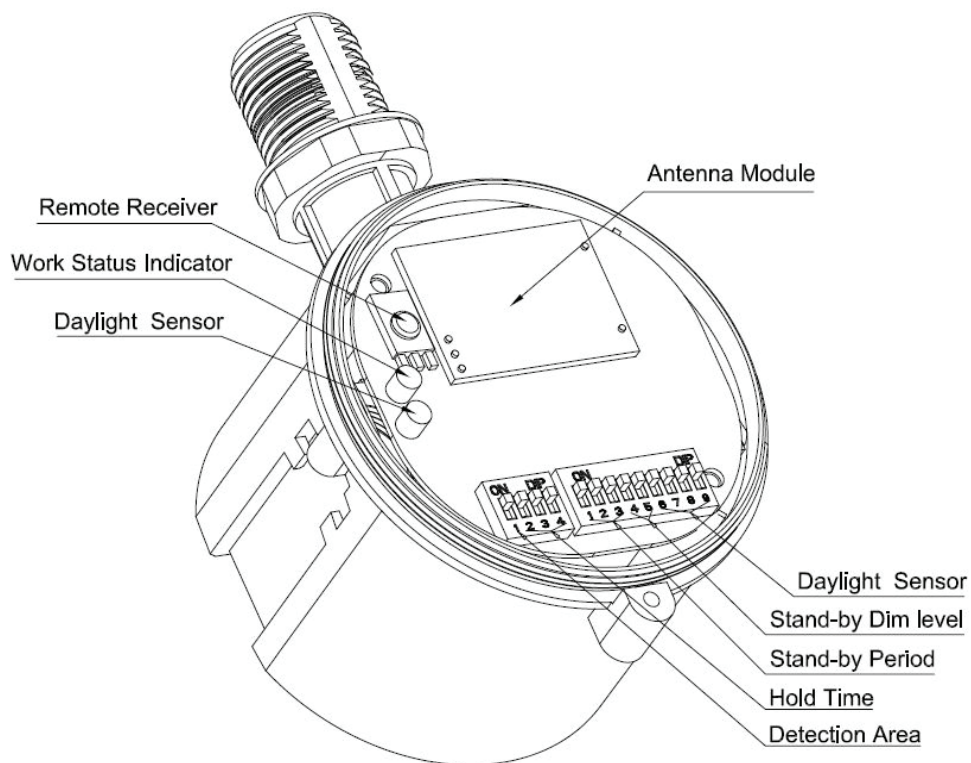

КОНТРОЛ

(HOLD TIME)

	2	3	4	
I	ON	ON	ON	5s
II	-	ON	ON	30s
III	ON	-	ON	1min
IV	-	-	ON	3min
V	ON	ON	-	20min
VI	-	-	-	30min

(STAND-BY PERIOD)

	1	2	3	
I	ON	ON	ON	0s
II	-	ON	ON	1min
III	ON	-	ON	3min
IV	-	-	ON	10min
V	ON	ON	-	30min
VI	-	-	-	+∞

(STAND-BY DIM LEVEL)

	4	5	%	1-10V
I	ON	ON	10%	1.4-1.6V
II	ON	-	20%	1.9-2.1V
III	-	ON	30%	2.9-3.1V
IV		-	50%	4.9-5.1V

(DAYLIGHT SENSOR)

	6	7	8	9	
I	ON	ON	ON	ON	5Lux
II	-	ON	ON	ON	15Lux
III	ON	-	ON	ON	30Lux
IV	-	-	ON	ON	50Lux
V	ON	ON	-	ON	100Lux
VI	ON	ON	ON	-	150Lux
VII	-	-	-	-	Disable*

(DETECTION AREA)

	1	
I	ON	100%
II	-	50%

ДИАГРАМА ЗА МОНТАЖ НА ТАВАН

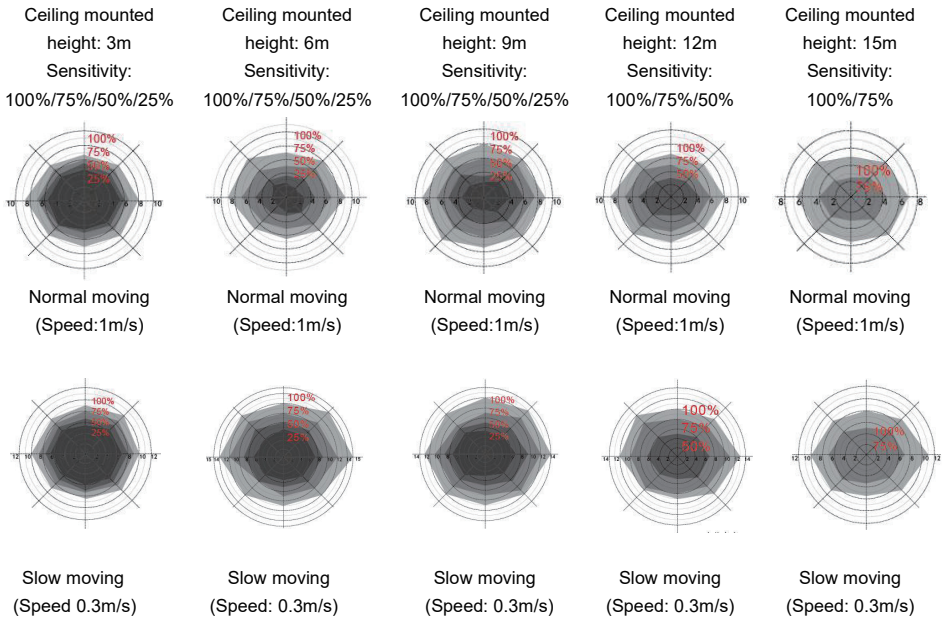

*Only 100%/75%/50% detection sensitivity is workable when installed at 10m & 15m mounting height. 25% sensitivity is not able to detect motion signal.

ЗАПОЧВАНЕ

1. Функция за включване/изключване /3-степенна функция за затъмнение:

След включване, сензорът автоматично включва осветлението на 100% яркост. След 10 секунди той изключва светлината. По време на инициализацията, сензорът не може да засича движение.

2. 2-степенна функция за затъмнение:

След включване, сензорът автоматично включва осветлението на 100% яркост. След 10 секунди той затъмнява светлината до ниско равнище на светлината (зададено от равнище на затъмнение в режим на изчакване). По време на инициализацията, сензорът не може да засича движение.

ФАБРИЧНА НАСТРОЙКАSETTING

Зона за засичане: 100%, време за задържане: 5S, период на изчакване: 0s, равнище на затъмнение на изчакване: 10%, сензор за дневна светлина: Спиране

УВЕДОМЛЕНИЕ ЗА ПРИЛОЖЕНИЕ

1) Сензорът трябва да бъде инсталиран от професионален електротехник. Моля изключете захранването преди инсталация, окабеляване, промяна на настройката на превключвател с двуредно разположени изводи [DIP].

2) Сензорът, който е инсталиран в пластмасовия и стъкления абажур редуцира чувствителността.

За всяко увеличение на дебелина с 3 mm, чувствителността се редуцира с 20%.

3) Резултатите на функцията за затъмнение може да се различават за различните драйвери 1-10v.

4) Прагът за светлинна чувствителност е в слънчева среда, без сенки и дифузно отражение на светлината на околната среда. Равнището на осветление на околната среда може да бъде различно в различната среда, климатично време, климат, час от деня и сезона.

5) Възможно е да се наложи да бъдат реконфигурирани параметрите на сензора в различни видове среда за инсталация.

6) Този сензор е за ползване само на закрито. Той ще окаже влияние върху водоустойчивото действие за употреба на открито. Вятърът, дъждът и движещите се обекти наоколо водят до ненужно задействане.

7) Разстоянието между каквито и да е индуктивни сензори трябва да бъде по-голямо от 3 m.

8) Не поставяйте сензора в близост до обекти с висока плътност, като например метални, стъклени, бетонни стени, тъй като е възможно ненужно задействане. Когато сензорът бъде инсталиран в метална лампа, метални отражателни повърхности или тясно затворено пространство, микровълните ще бъдат отразявани многократно и ще причинят ненужно задействане. Моля редуцирайте чувствителността или се свържете с производителя за техническа поддръжка.

9) Моля уверете се, че няма движещи се сигнали около сензора, като например вентилатор, правотоково задвижване, канализационна тръба, изход за въздух и т.н., сензорът може да генерира ненужно задействане.

10) Съветваме ви да проведете тест на 5 образци преди масовото приложение на сензора в нов проект за осветление.

11) Поради постоянно подобрене, съдържанието на тези инструкции могат да бъдат заменени без предизвестие.

ISTRUZIONI DI INSTALLAZIONE HIGHBAY SENSOR



5 YEARS
WARRANTY*

INTRODUZIONE E GARANZIA

Grazie per aver scelto e acquistato il prodotto della V-TAC. La V-TAC Le servirà nel miglior modo possibile. Si prega di leggere attentamente queste istruzioni prima di iniziare l'installazione e di conservare questo manuale a portata di mano per riferimenti futuri. In caso di qualunque altra domanda si prega di contattare il nostro rivenditore o il distributore locale da chi è stato acquistato il prodotto. Loro sono addestrati e pronti a servirla nel miglior modo possibile. La garanzia è valida per 5 anni dalla data d'acquisto. La garanzia non si applica ai danni provocati dall'installazione errata o dall'usura anomala. L'azienda non fornisce alcuna garanzia per danni a qualsiasi superficie a causa della rimozione e dell'installazione errata del prodotto.

ATTENZIONE

1. Si prega di leggere queste istruzioni e scollegare l'alimentazione prima di iniziare l'installazione.
2. Installazione soltanto da parte di un elettricista certificato



Questo marchio indica che questo prodotto non deve essere smaltito con gli altri rifiuti domestici.



Attenzione, rischio di scossa elettrica.

CARATTERISTICHE DEL PRODOTTO

1. Tensione di esercizio 100/277 V AC, 50/60 Hz.
2. L'altezza di montaggio dell'antenna a microonde è di un massimo di 15 m, adatta per l'installazione nella maggior parte dei magazzini.
3. Supporta modalità ad alta e bassa sensibilità (per soffitti in metallo, supporti di montaggio di riflettori in metallo) e funziona con driver LED dimmerabile 1-10 V con funzione di dimmerazione a 2 o 3 fasi facile da ottenere.
4. Compatibile con i modelli della V-TAC Highbay VT-9-151 e VT-9-200.

PARAMETRI

Input	Operating Voltage Range	108-305V AC, 50Hz/60Hz
	DC Input Voltage	N/A
	Rated Voltage	100/277V AC, 50Hz/60Hz
	No-load Power	N/A
	Stand-by Power	<1W
Output	Surge Test	L-N: 1kV
	Working Mode	ON/OFF function, 1-10V step dimming
	Type of Load	Inductive or resistive Load
	Load Capacity	100VAC: 4A; 277VAC: 3A
	Current of Load	N/A
Dim Interface	Max. Surge Capacity	50A (50% Ipeak, twidth =500uS, 230Vac full load, cold start);
		80A (50% Ipeak, twidth =200uS, 230Vac, full load, cold start)
	1-10V Dimming	< 50mA (Non-constant source) 10%(1.4-1.6V), 20%(1.9-2.1V), 30%(2.9-3.1V), 50% (4.9-5.1V)
	Synchronous Control	N/A
Sensor Parameters	High Low-level	N/A
	PWM Control	N/A
	Operating Frequency	5.8 GHz \pm 75 MHz, ISM Band.
	Transmitting power	0.5mW Max.
	Hold time	5s/30s/1min/3min/5min/10min/20min/30min
Others	Stand-by DIM Level	10%/20%/30%/50%
	Stand-by Period	0s/10s/1min/3min/5min/10min/30min/+ ∞
	Detection Area	25%/50%/75%/100%
	Daylight Sensor	5lux/15lux/30lux/50lux/100lux/150lux/Disable (Ambient light diffusion)
	Mounting Height	15m Max
	Detecting Angle	360°(ceiling mounting)
	Operating Environment	Operating Temperature
Storage Temperature		Temperature:-40 to +80; Humidity:10%-95% (non-condensing)
Others	Wiring	H05RR-F,5*18AWG exposed line length: 810-830mm
	Wiring Color	Sheath: blue, brown, red, purple, gray
	IP Rating	IP65
	Protection Class	Class II
	Installation	Independent
	Dimension	(Φ xH)72*59mm
Lifetime	50,000h @ Ta Full load	

Annotazione

1. "N/A" significa non disponibile.
2. La zona di rilevamento dipende dal volume dell'oggetto in movimento e dalla velocità di movimento. La zona di rilevamento viene testata da una persona alta 165 cm che si muove con la velocità di 0,5 m/s.

FUNZIONI

1) Funzione ATTIVAZIONE/DISATTIVAZIONE (periodo di stand-by impostato su "0" secondi)

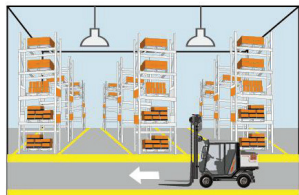

1. Con sufficiente luce naturale, la luce non verrà ATTIVATA anche se è presente il segnale di movimento.

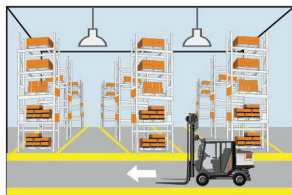

2. Con sufficiente luce naturale, il sensore attiverà la luce quando viene rilevato un movimento.

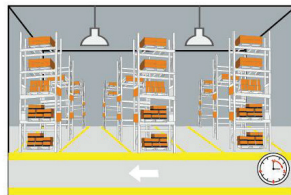

3. Trascorso il tempo di attesa, il sensore disattiverà la luce quando non viene rilevato nessun movimento.

2) Funzione di regolazione della luminosità/dimmerazione a 2 fasi (il periodo di stand-by deve essere impostato su "+∞")

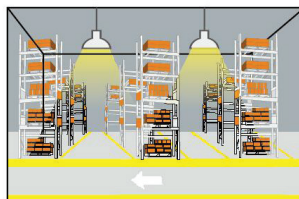

1. Se non viene rilevato nessun movimento, la luce rimarrà sempre ad un livello di illuminazione basso.

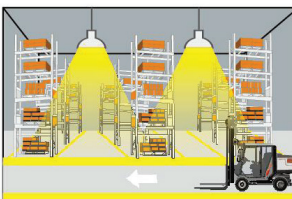

2. Quando viene rilevato un movimento, il sensore attiva la luce al 100% di luminosità.

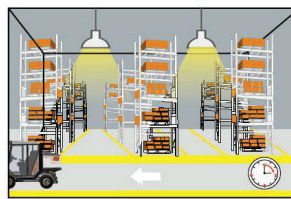

3. Trascorso il tempo di attesa, il sensore attenua la luce all'attuale basso livello di illuminazione se non viene rilevato nessun movimento.

3) Funzione di regolazione della luminosità/dimmerazione a 3 fasi (il periodo di standby deve essere impostato su "10 secondi / 1 minuto / 3 minuti / 5 minuti / 10 minuti / 30 minuti")

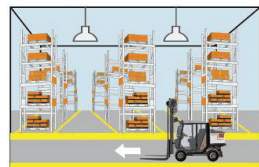

1. Con sufficiente luce naturale, la luce non verrà attivata anche se è presente il segnale di movimento.

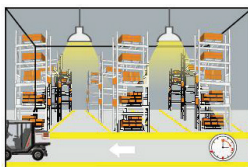

3. Trascorso il tempo di attesa, il sensore attenua la luce ad un livello di illuminazione basso se non viene rilevato nessun nuovo movimento.

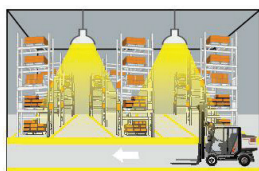

2. Con sufficiente luce naturale, il sensore attiverà la luce quando viene rilevato un movimento.

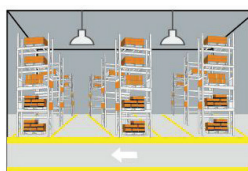

4. Trascorso il periodo di standby, il sensore disattiva la luce se non viene rilevato nessun movimento nella zona di rilevamento.

DIAGRAMMA DEI DIMENSIONI

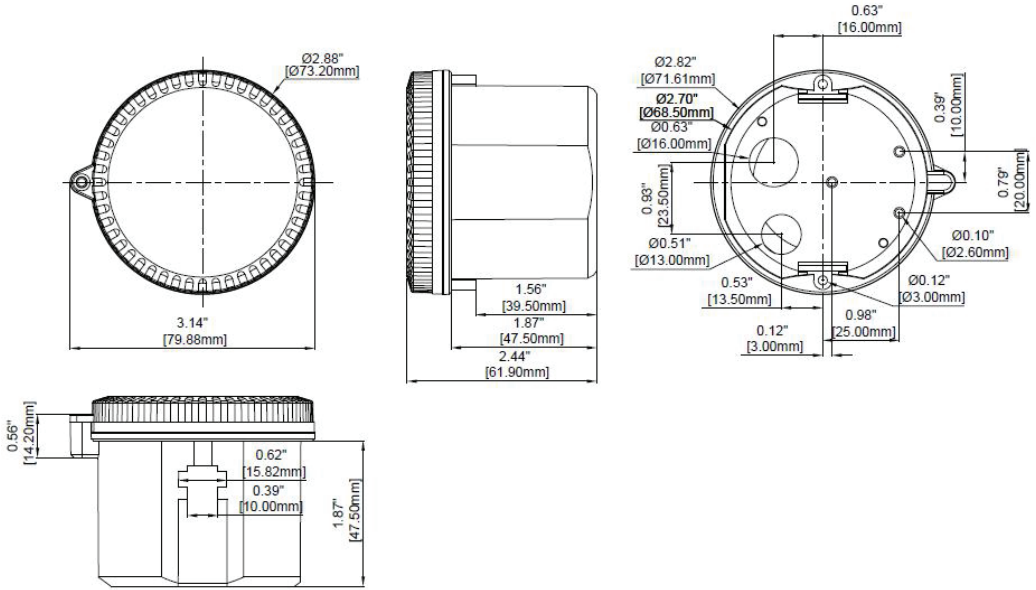

SCHEMA ELETTRICO

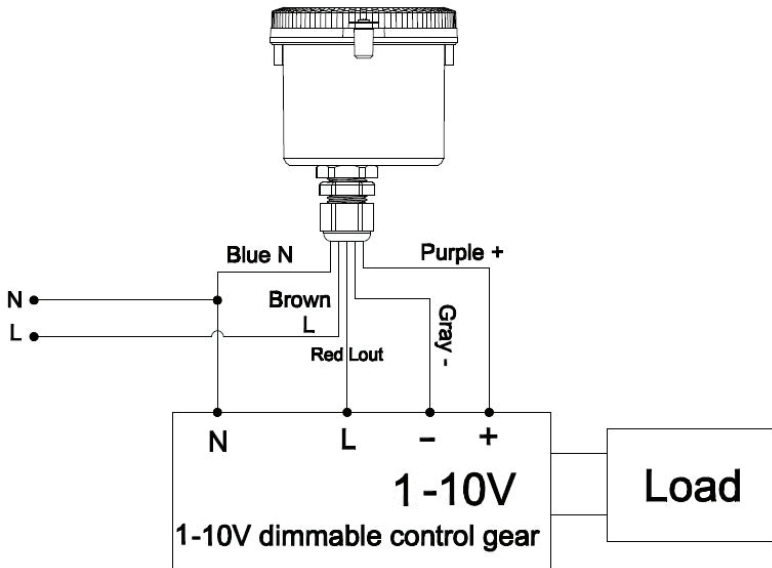

SCHEMA DI INSTALLAZIONE



DIAGRAMMA DELLE FUNZIONI



CONTROLLI

(HOLD TIME)

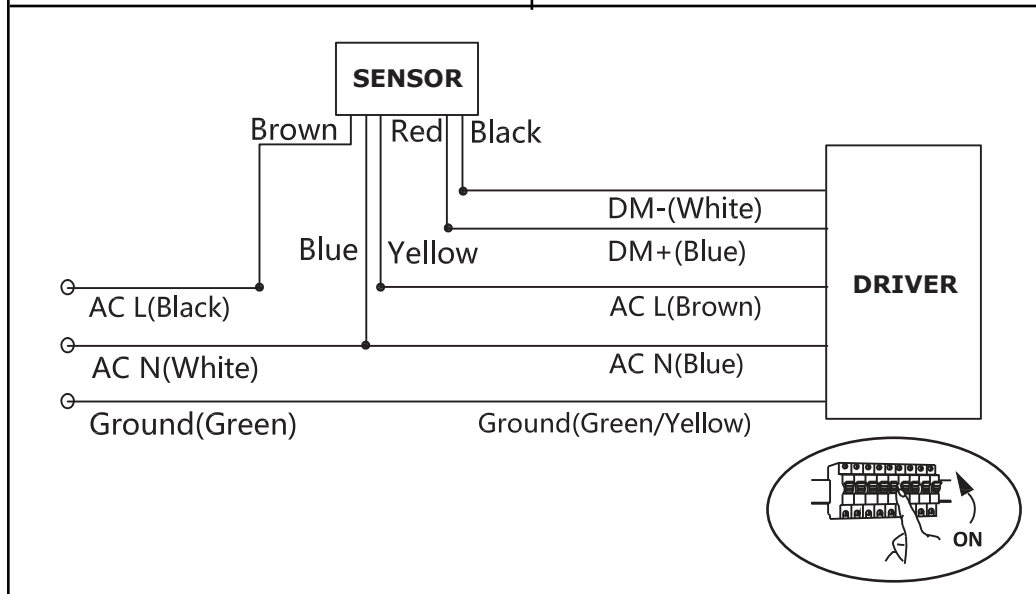
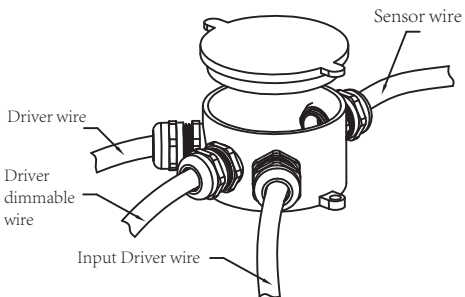
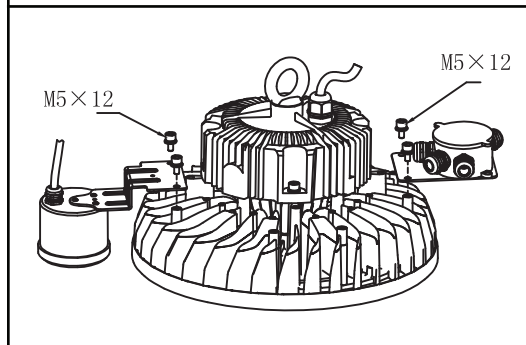
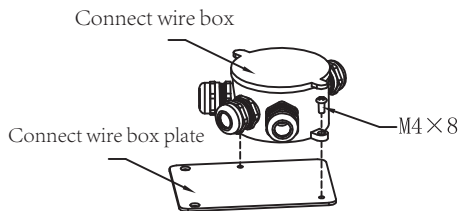
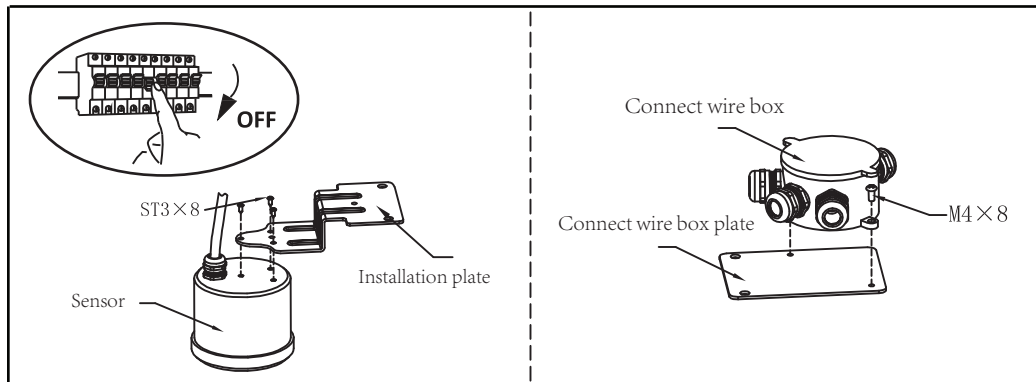
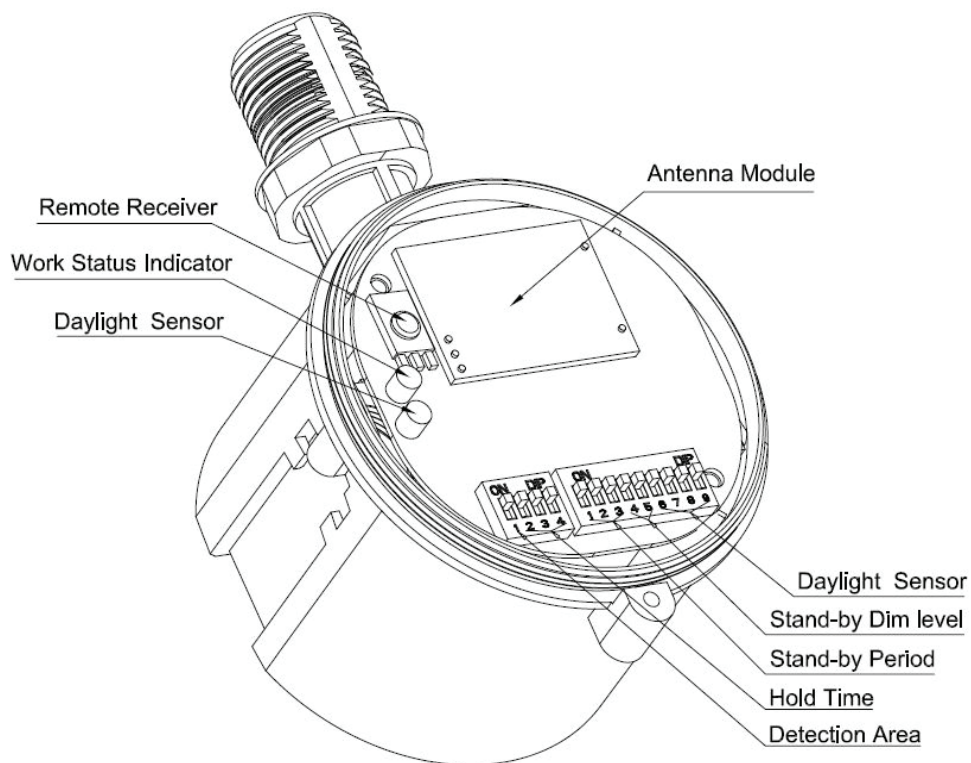
	2	3	4	
I	ON	ON	ON	5s
II	-	ON	ON	30s
III	ON	-	ON	1min
IV	-	-	ON	3min
V	ON	ON	-	20min
VI	-	-	-	30min

(STAND-BY PERIOD)

	1	2	3	
I	ON	ON	ON	0s
II	-	ON	ON	1min
III	ON	-	ON	3min
IV	-	-	ON	10min
V	ON	ON	-	30min
VI	-	-	-	+∞

(STAND-BY DIM LEVEL)

	4	5	%	1-10V
I	ON	ON	10%	1.4-1.6V
II	ON	-	20%	1.9-2.1V
III	-	ON	30%	2.9-3.1V
IV		-	50%	4.9-5.1V

(DAYLIGHT SENSOR)

	6	7	8	9	
I	ON	ON	ON	ON	5Lux
II	-	ON	ON	ON	15Lux
III	ON	-	ON	ON	30Lux
IV	-	-	ON	ON	50Lux
V	ON	ON	-	ON	100Lux
VI	ON	ON	ON	-	150Lux
VII	-	-	-	-	Disable*

(DETECTION AREA)

	1	
I	ON	100%
II	-	50%

SCHEMA DI MONTAGGIO AL SOFFITTO

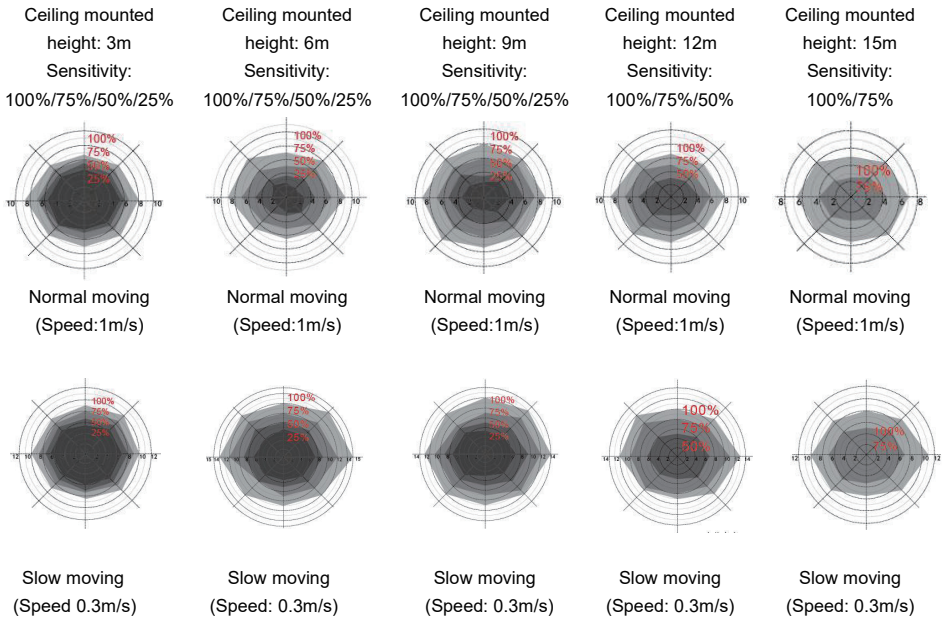

*Only 100%/75%/50% detection sensitivity is workable when installed at 10m & 15m mounting height. 25% sensitivity is not able to detect motion signal.

INIZIALIZZAZIONE

1. Funzione di attivazione/disattivazione / Funzione di regolazione della luminosità/dimmerazione a 3 fasi:

Dopo l'attivazione, il sensore attiva automaticamente la luce al 100% di luminosità. Dopo 10 secondi la luce viene disattivata. Durante l'inizializzazione, il sensore non è in grado di rilevare il movimento.

2. Funzione di regolazione della luminosità/dimmerazione a 2 fasi:

Dopo l'attivazione, il sensore attiva automaticamente la luce al 100% di luminosità. Dopo 10 secondi la luce viene dimmerata ad un livello di illuminazione basso (impostato dal livello di dimmerazione in stand-by). Durante l'inizializzazione il sensore non è in grado di rilevare il movimento.

IMPOSTAZIONI DI FABBRICA

Zona di rilevamento: 100%, Tempo di attesa: 5 secondi, Periodo di standby: 0 secondi, Livello di dimmerazione in standby: 10%, Sensore di luce diurna: disabilitato.

AVVISO DI APPLICAZIONE

- 1) Il sensore deve essere installato da un elettricista professionista. Disattivare l'alimentazione prima di iniziare l'installazione, il cablaggio, le modifiche delle impostazioni dell'interruttore DIP (interruttore in contenitore dual in line).
- 2) Il sensore installato nel paralume in plastica e in vetro riduce la sensibilità. Per ogni aumento di spessore di 3 mm, la sensibilità viene ridotta del 20%.
- 3) I risultati della funzione di regolazione della luminosità/dimmerazione possono differire per i diversi driver 1-10v.
- 4) La soglia di sensibilità alla luce è in un ambiente soleggiato, senza ombra e riflessione diffusa della luce naturale. Il livello di illuminazione naturale può variare a seconda dell'ambiente, del tempo, del clima, dell'ora del giorno e della stagione.
- 5) Potrebbe essere necessario riconfigurare i parametri del sensore in diversi ambienti di installazione.
- 6) Questo sensore è destinato esclusivamente ad uso interno. Influirà sull'effetto impermeabile se viene utilizzato all'esterno. Il vento, la pioggia e gli oggetti in movimento possono causare attivazioni non necessarie.
- 7) La distanza tra i sensori induttivi dovrebbe essere maggiore di 3 m.
- 8) Non posizionare il sensore vicino a oggetti ad alta densità come metallo, vetro, pareti di cemento, ecc., potrebbe verificarsi un'attivazione non necessaria. Quando il sensore viene installato in un paralume in metallo, una superficie riflettente in metallo o in un ambiente chiuso stretto, le microonde verranno riflesse ripetutamente e causeranno un'attivazione non necessaria. Ridurre la sensibilità o contattare il produttore per l'assistenza tecnica.
- 9) Assicurarsi che non vi siano segnali in movimento attorno al sensore, come ventilatori, motori in corrente continua, tubi fognari, uscite dell'aria, ecc., il sensore potrebbe causare attivazioni non necessarie.
- 10) Si consiglia di testare 5 campioni prima dell'applicazione di massa del sensore in un nuovo progetto di illuminazione.
- 11) A causa del miglioramento continuo, il contenuto di queste istruzioni potrebbe essere modificato senza preavviso.

FELSZERELÉSI ÚTMUTATÓ HIGHBAY SENSOR



5 YEARS
WARRANTY*

BEVEZETÉS ÉS GARANCIA

Köszönjük, hogy választotta és megvásárolta a V-TAC terméket. V-TAC nyújtja Önnek a legjobb szolgáltatást. Kérjük, a szerelés előtt figyelmesen olvassa el ezeket az utasításokat és óvja ezt a kézikönyvet későbbi használatra. Ha további kérdései vannak, kérjük, forduljon forgalmazójához vagy helyi eladójához, akitől megvásárolta a terméket. Ők képzettek és készek a legjobb szolgálatra. A jótállás a vásárlás napjától számítva 5 évig érvényes. A garancia nem vonatkozik a helytelen szerelés vagy az abnormális kopás okozta károkra. A cég nem vállal semmilyen garanciát a felület károsodásáért, a termék helytelen eltávolításáért és szereléséért.

FIGYELEM

1. Kérjük, a szerelés megkezdése előtt kapcsolja ki az áramellátást és olvassa el ezt az útmutatót.
2. Csak szakképzett villanyszerelő szerelheti fel.



Ez a jelölés azt jelzi, hogy a terméket nem szabad más háztartási hulladékkal együtt megsemmisíteni



Vigyázat, áramütés veszélye.

A TERMÉK JELLEMZŐI

1. Működési feszültség 100/277V AC, 50/60Hz
2. A mikrohullámú antenna beszerelési magassága legfeljebb 15 m, a legtöbb raktárban felszerelhető.
3. Támogatja a nagy érzékenyséű és az alacsony érzékenyséű üzemmódot (fém mennyezetekhez, fém reflektorok beszerelési környezetéhez) és 1-10 V-os tompítható LED-es meghajtóval történő munka, könnyen megvalósítható 2 vagy 3 lépcsős tompítási funkcióval.
4. Kompatibilis a V-TAC Highbay VT-9-151 és VT-9-200 modellekkel

PARAMÉTEREK

Input	Operating Voltage Range	108-305V AC, 50Hz/60Hz
	DC Input Voltage	N/A
	Rated Voltage	100/277V AC, 50Hz/60Hz
	No-load Power	N/A
	Stand-by Power	<1W
Output	Surge Test	L-N: 1kV
	Working Mode	ON/OFF function, 1-10V step dimming
	Type of Load	Inductive or resistive Load
	Load Capacity	100VAC: 4A; 277VAC: 3A
	Current of Load	N/A
Dim Interface	Max. Surge Capacity	50A (50% Ipeak, twidth =500uS, 230Vac full load, cold start);
		80A (50% Ipeak, twidth =200uS, 230Vac, full load, cold start)
	1-10V Dimming	< 50mA (Non-constant source) 10%(1.4-1.6V), 20%(1.9-2.1V), 30%(2.9-3.1V), 50% (4.9-5.1V)
	Synchronous Control	N/A
Sensor Parameters	High Low-level	N/A
	PWM Control	N/A
	Operating Frequency	5.8 GHz \pm 75 MHz, ISM Band.
	Transmitting power	0.5mW Max.
	Hold time	5s/30s/1min/3min/5min/10min/20min/30min
Others	Stand-by DIM Level	10%/20%/30%/50%
	Stand-by Period	0s/10s/1min/3min/5min/10min/30min/+ ∞
	Detection Area	25%/50%/75%/100%
	Daylight Sensor	5lux/15lux/30lux/50lux/100lux/150lux/Disable (Ambient light diffusion)
	Mounting Height	15m Max
	Detecting Angle	360°(ceiling mounting)
	Operating Environment	Operating Temperature
Storage Temperature		Temperature:-40 to +80; Humidity:10%-95% (non-condensing)
Others	Wiring	H05RR-F,5*18AWG exposed line length: 810-830mm
	Wiring Color	Sheath: blue, brown, red, purple, gray
	IP Rating	IP65
	Protection Class	Class II
	Installation	Independent
	Dimension	(Φ xH)72*59mm
Lifetime	50,000h @ Ta Full load	

Megjegyzés

1. "N/A" azt jelenti, hogy nem érhető el.
2. A detektálási terület a mozgás tárgyának térfogata és a mozgás sebessége befolyásolja. Az érzékelési területet 165 cm magas személy teszteli, és a gyaloglási sebesség 0,5 m/s.

FUNKCIÓK

1) BE/KI funkció (a készenléti idő „0”-ra állítva)

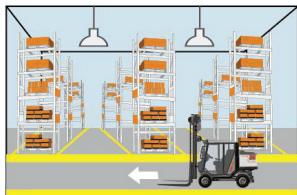

1. Ha elegendő környezeti fény van, akkor a fényt sem kapcsol be, még ha mozgásjel jelen van.

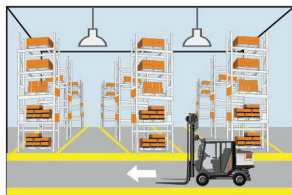

2. Elegendő környezeti fény mellett az érzékelő mozgás észlelésekor bekapcsolja a fényt.

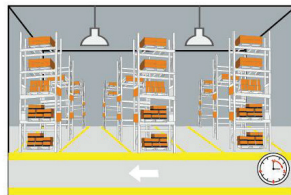

3. A tartási idő elteltével az érzékelő kikapcsolja a fényt, amikor nem észlel mozgást.

2) Kétlépcsős tompítás funkció (a készenléti időt „+ ∞” értékre kell állítani)

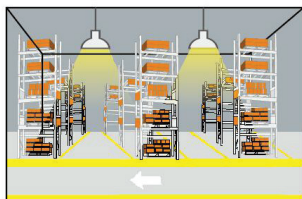

1. Ha nem észlel mozgást, akkor a lámpa folyamatosan alacsony szintű fényvel világít.

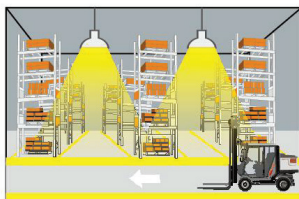

2. Ha mozgást észlel, az érzékelő a fényt 100% -os fényerőre kapcsolja be.

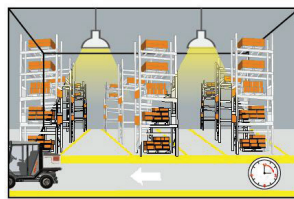

3. A tartási idő eltelte után az érzékelő tompítja a fényt a jelenlegi gyenge fényszinten, ha nem észlel mozgást.

3) Háromlépcsős tompítás funkció (a készenléti időt „10 másodperc / 1 perc / 3 perc / 5 perc / 10 perc / 30 perc” értékre kell állítani)

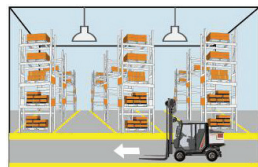

1. Ha elegendő környezeti megvilágítás van, akkor a lámpa akkor sem kapcsol be, ha mozgási jel van jelen.

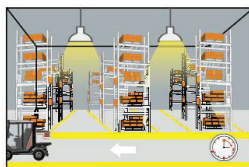

3. A tartási idő eltelte után az érzékelő tompítja a fényt alacsony fényviszonyok között, ha nem észlel új mozgást.

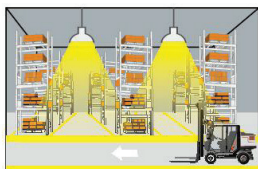

2. Elegendő környezeti fény mellett az érzékelő mozgás észlelésekor bekapcsolja a fényt.

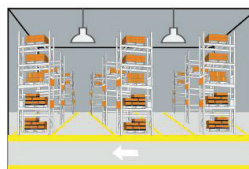

4. A készenléti időszak elteltét követően az érzékelő kikapcsolja a fényt, ha az észlelési zónában nem észlel mozgást.

MÉRETDIAGRAM

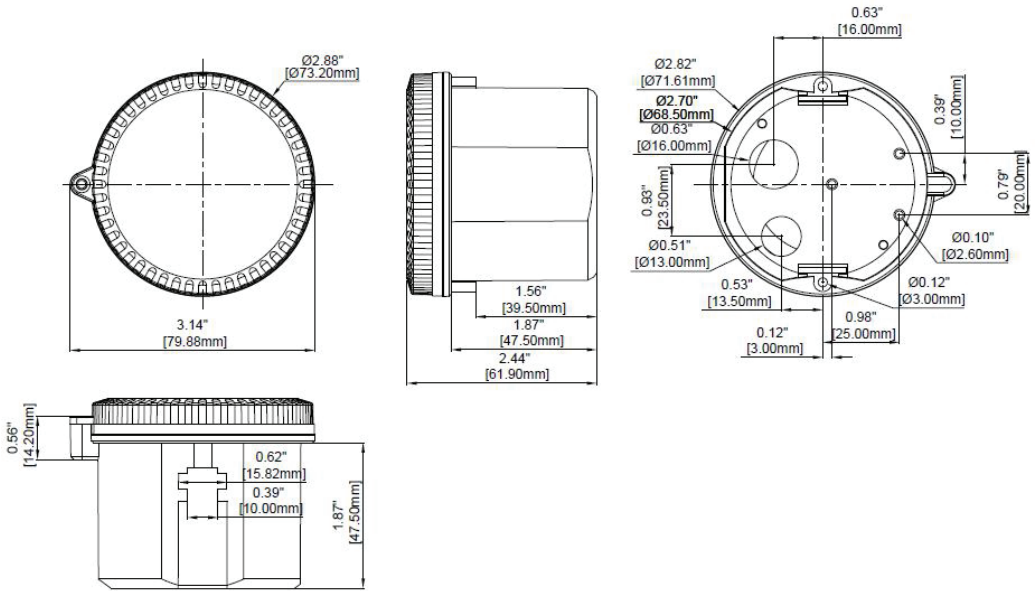

KAPCSOLÁSI RAJZ

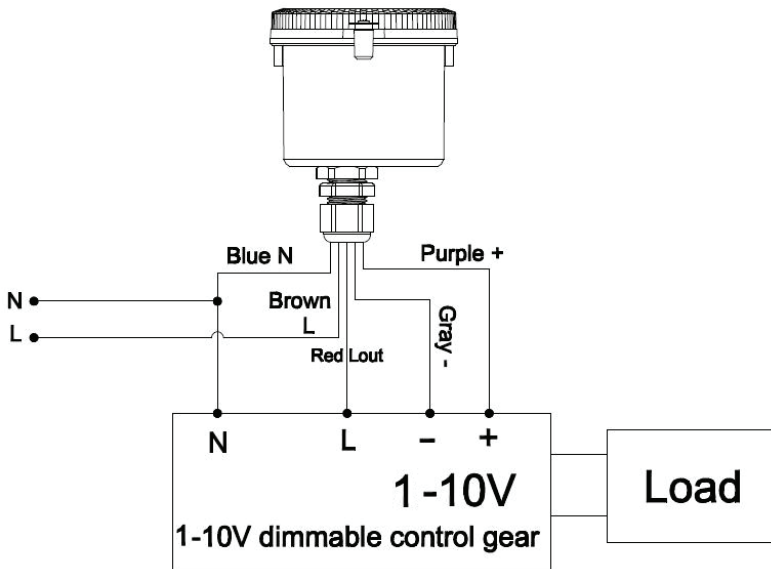

TELEPÍTÉSI RAJZ

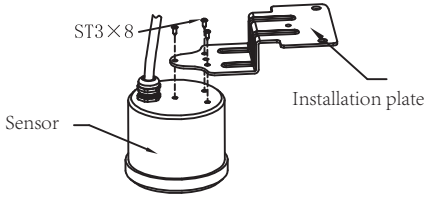
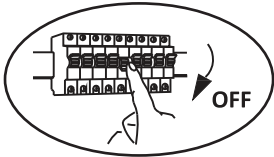

Connect wire box

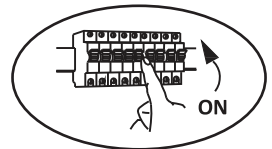
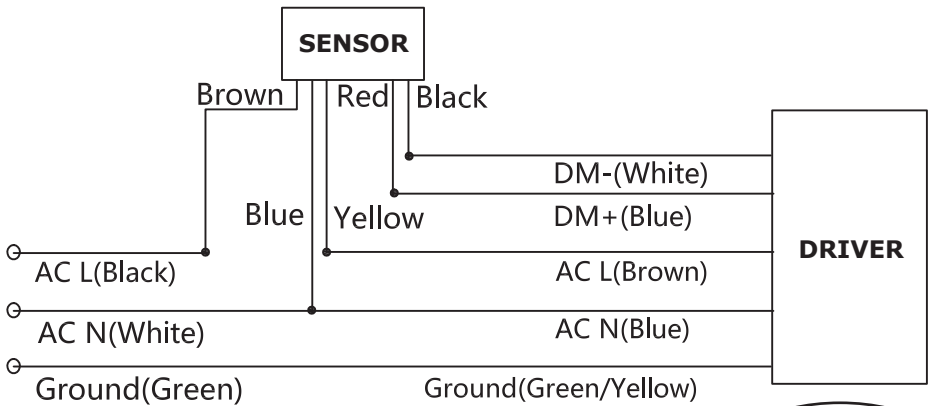
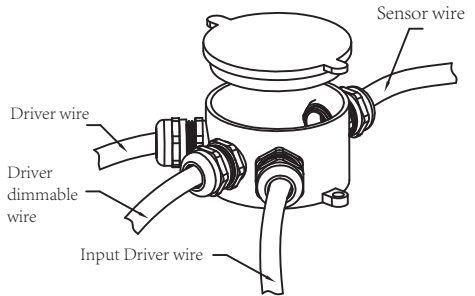
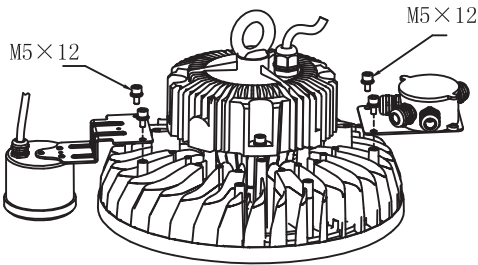
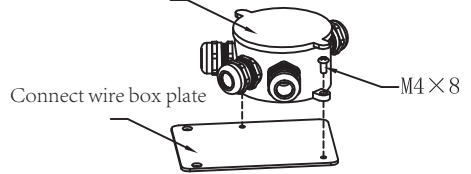

MŰKÖDÉSI DIAGRAM

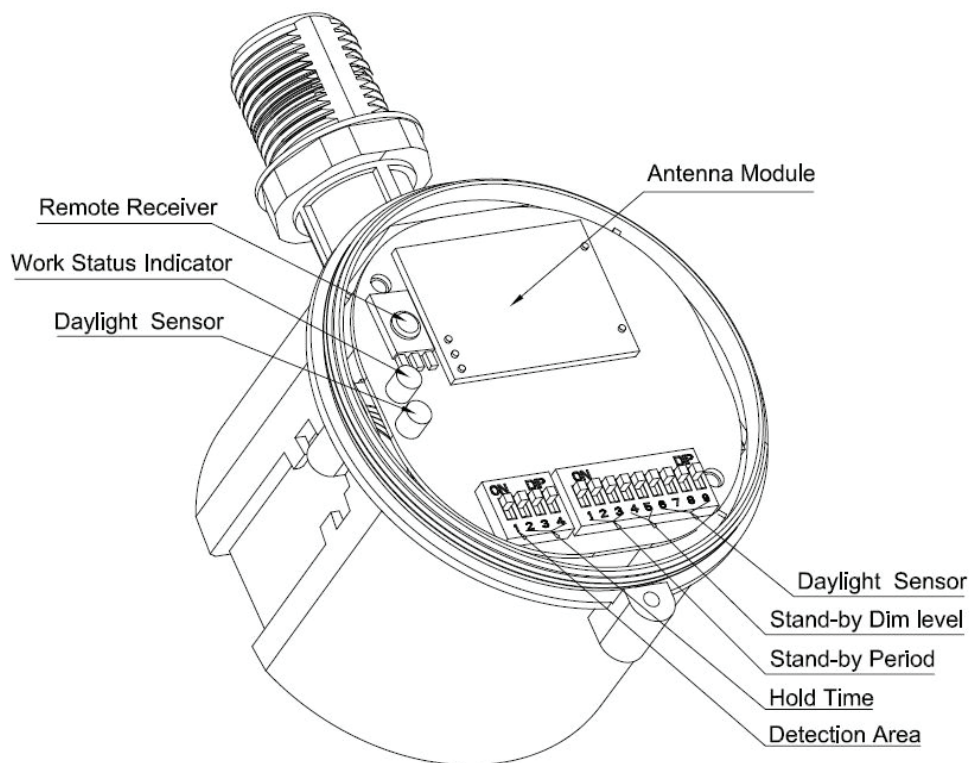

KEZELŐSZERVEK

(HOLD TIME)

	2	3	4	
I	ON	ON	ON	5s
II	-	ON	ON	30s
III	ON	-	ON	1min
IV	-	-	ON	3min
V	ON	ON	-	20min
VI	-	-	-	30min

(STAND-BY PERIOD)

	1	2	3	
I	ON	ON	ON	0s
II	-	ON	ON	1min
III	ON	-	ON	3min
IV	-	-	ON	10min
V	ON	ON	-	30min
VI	-	-	-	+∞

(STAND-BY DIM LEVEL)

	4	5	%	1-10V
I	ON	ON	10%	1.4-1.6V
II	ON	-	20%	1.9-2.1V
III	-	ON	30%	2.9-3.1V
IV		-	50%	4.9-5.1V

(DAYLIGHT SENSOR)

	6	7	8	9	
I	ON	ON	ON	ON	5Lux
II	-	ON	ON	ON	15Lux
III	ON	-	ON	ON	30Lux
IV	-	-	ON	ON	50Lux
V	ON	ON	-	ON	100Lux
VI	ON	ON	ON	-	150Lux
VII	-	-	-	-	Disable*

(DETECTION AREA)

	1	
I	ON	100%
II	-	50%

MENNYEZETI SZERELÉSI RAJZ

Ceiling mounted
height: 3m
Sensitivity:
100%/75%/50%/25%

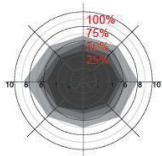

Normal moving
(Speed:1m/s)

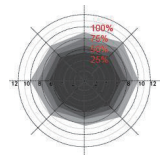

Slow moving
(Speed 0.3m/s)

Ceiling mounted
height: 6m
Sensitivity:
100%/75%/50%/25%

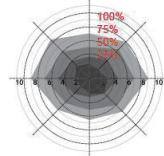

Normal moving
(Speed:1m/s)

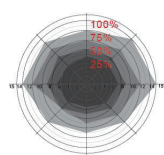

Slow moving
(Speed: 0.3m/s)

Ceiling mounted
height: 9m
Sensitivity:
100%/75%/50%/25%

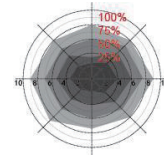

Normal moving
(Speed:1m/s)

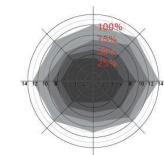

Slow moving
(Speed: 0.3m/s)

Ceiling mounted
height: 12m
Sensitivity:
100%/75%/50%

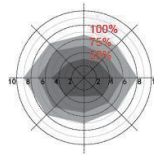

Normal moving
(Speed:1m/s)

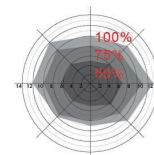

Slow moving
(Speed: 0.3m/s)

Ceiling mounted
height: 15m
Sensitivity:
100%/75%

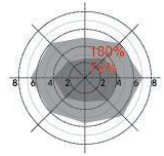

Normal moving
(Speed:1m/s)

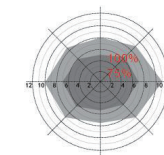

Slow moving
(Speed: 0.3m/s)

*Only 100%/75%/50% detection sensitivity is workable when installed at 10m & 15m mounting height. 25% sensitivity is not able to detect motion signal.

INICIALIZÁLÁS

1. Be/KI funkció / Háromfokozatú tompítás funkció:

Bekapcsolás után az érzékelő automatikusan 100%-os fényerővel bekapcsol. 10 másodperc után kikapcsolja a lámpákat. Az inicializálás alatt az érzékelő nem képes felismerni a mozgást.

2. Kétlépcsős tompítás funkció:

Bekapcsolás után az érzékelő automatikusan 100%-os fényerővel bekapcsol. 10 másodperc elteltével tompítja a fényt alacsony szintre (készületi halvány szinttel állítva). Az inicializálás alatt az érzékelő nem képes felismerni a mozgást.

GYÁRI BEÁLLÍTÁS

Érzékelési terület: 100%, várakozási idő: 5 másodperc, készületi idő: 0 másodperc, készületi tompítás szintje: 10%, nyári fényérzékelő: letiltva

ÉRTESÍTÉS ALKALMAZÁSRÓL

- 1) Az érzékelőt professzionális villanyszerelőnek kell telepítenie. Kérjük, kapcsolja ki a készüléket, mielőtt telepítené, húzalozná, megváltoztatná a kétsoros kimenetű, DIP kapcsoló beállítását.
- 2) A műanyag és üveg lámpaernyőbe beépített érzékelő csökkenti az érzékenységet. Minden vastagság 3 mm-es növekedése esetén az érzékenység 20%-kal csökken.
- 3) A tompítási teljesítmény eltérhet a különféle 1-10V-os meghajtóknál.
- 4) A fényérzékelési küszöb napos környezetben van, nincs árnyék és a környezeti fény diffúziója. A környezeti lux szintje különbözhet a különböző környezetektől, időjárástól, éghajlattól, a napszakoktól és az évszakoktól függően.
- 5) Előfordulhat, hogy az érzékelő paramétereit különböző telepítési környezetekben újra kell konfigurálni.
- 6) Ez az érzékelő csak beltéri használatra szolgál. Ez befolyásolja a kültéri használatra szánt vízhatást. A szél, az eső és a körül mozgó tárgyak téves világítást okoznak.
- 7) Az induktív érzékelők közötti távolságnak nagyobbnak kell lennie, mint 3 m.
- 8) Ne tegye az érzékelőt nagy sűrűségű tárgyak, például fém, üveg, betonfalak, stb. közelében, hamis elindulás történhet. Ha az érzékelőt fémlámpába, fém fényvisszaverő felületbe vagy egy szűk, zárt környezetbe telepítik, a mikrohullám többször visszatükröződik, és téves világítást okoz. Kérjük, csökkentse az érzékenységet, vagy vegye fel a kapcsolatot a gyártóval műszaki támogatásért.
- 9) Győződjön meg arról, hogy az érzékelő körül nincsenek mozgó jelek, például ventilátor, egyenáramú motor, csatornacső, levegőkezelés, stb., az érzékelő hamis jelet generálhat.
- 10) Javasoljuk, hogy teszteljen 5 mintát, mielőtt az érzékelőt tömegesen alkalmazná egy új világítási projektben.
- 11) A folyamatos fejlesztés miatt ennek az utasításnak a tartalma előzetes értesítés nélkül megváltoztatható.

INSTALLATIONSANWEISUNGEN HIGHBAY SENSOR



5 YEARS
WARRANTY*

EINFÜHRUNG UND GEBRAUCHSANWEISUNG

Wir danken Ihnen, dass Sie ein V-TAC ausgesucht und gekauft haben. V-TAC wird Ihnen die besten Dienste erweisen. Lesen Sie, bitte, diese Gebrauchsanweisung vor der Montage aufmerksam durch und halten Sie sie für Auskünfte in der Zukunft parat. Sollten Sie weitere Fragen haben, kontaktieren Sie, bitte, unseren lokalen Händler oder Verkäufer, von dem Sie das Produkt gekauft haben. Sie sind ausgebildet und bereit Sie auf die bestmögliche Art und Weise zu unterstützen. Die Gewährleistungsfrist beträgt 5 Jahre ab dem Kaufdatum. Die Gewährleistung bezieht sich nicht auf Schäden, die durch unsachgemäße Montage oder ungewöhnliche Abnutzung und Verschleiß verursacht worden sind. Das Unternehmen gewährt keine Garantie für durch unsachgemäßen Produktabbau oder unsachgemäße Montage entstandene Schäden an jeglichen Oberflächen.

ACHTUNG

1. Bitte schalten Sie die Stromversorgung aus und lesen Sie diese Anleitung, bevor Sie mit der Installation beginnen.
2. Installation nur von Elektrofachkräften



Diese Kennzeichnung weist darauf hin, dass dieses Produkt nicht mit anderen Haushaltsabfällen entsorgt werden darf.



Vorsicht, Stromschlaggefahr.

PRODUKT EIGENSCHAFTEN

1. Betriebsspannung 100/277 V AC, 50/60 Hz
2. Die Montagehöhe der Mikrowellenantenne beträgt maximal 15 m und ist für die Installation in den meisten Lagern geeignet.
3. Unterstützt hochempfindliche und niedrigempfindliche Modi (für Metalldecken, Metallreflektor-Montageumgebungen) und arbeitet mit einem dimmbaren 1-10-V-LED-Treiber, der leicht zu erreichen ist.
4. Kompatibel mit den V-TAC Highbay-Modellen VT-9-151 und VT-9-200

PARAMETER

Input	Operating Voltage Range	108-305V AC, 50Hz/60Hz
	DC Input Voltage	N/A
	Rated Voltage	100/277V AC, 50Hz/60Hz
	No-load Power	N/A
	Stand-by Power	<1W
Output	Surge Test	L-N: 1kV
	Working Mode	ON/OFF function, 1-10V step dimming
	Type of Load	Inductive or resistive Load
	Load Capacity	100VAC: 4A; 277VAC: 3A
	Current of Load	N/A
Dim Interface	Max. Surge Capacity	50A (50% I _{peak} , twidth =500uS, 230Vac full load, cold start);
		80A (50% I _{peak} , twidth =200uS, 230Vac, full load, cold start)
		< 50mA (Non-constant source)
	1-10V Dimming	10%(1.4-1.6V), 20%(1.9-2.1V), 30%(2.9-3.1V), 50% (4.9-5.1V)
	Synchronous Control	N/A
Sensor Parameters	High Low-level	N/A
	PWM Control	N/A
	Operating Frequency	5.8 GHz ±75 MHz, ISM Band.
	Transmitting power	0.5mW Max.
	Hold time	5s/30s/1min/3min/5min/10min/20min/30min
Others	Stand-by DIM Level	10%/20%/30%/50%
	Stand-by Period	0s/10s/1min/3min/5min/10min/30min/+∞
	Detection Area	25%/50%/75%/100%
	Daylight Sensor	5lux/15lux/30lux/50lux/100lux/150lux/Disable (Ambient light diffusion)
	Mounting Height	15m Max
	Detecting Angle	360°(ceiling mounting)
	Operating Environment	Operating Temperature
Storage Temperature		Temperature:-40 to +80; Humidity:10%-95% (non-condensing)
Others	Wiring	H05RR-F,5*18AWG exposed line length: 810-830mm
	Wiring Color	Sheath: blue, brown, red, purple, gray
	IP Rating	IP65
	Protection Class	Class II
	Installation	Independent
	Dimension	(ΦxH)72*59mm
Lifetime	50,000h @ Ta Full load	

Anmerkung

1. "N/A" steht für "nicht verfügbar".
2. Der Erkennungsbereich gilt in Abhängigkeit vom Volumen des Bewegungsobjekts und seiner Bewegungsgeschwindigkeit. Der Erkennungsbereich wurde getestet mit einer 165 cm großen Person, die sich mit einer Gehgeschwindigkeit von 0,5 m/s bewegt.

FUNKTIONEN

1. EIN/AUS Funktion (Standby-Zeit auf "0" s eingestellt)

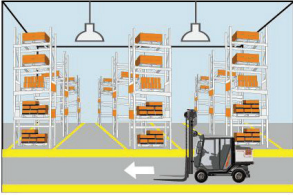

1. Bei ausreichendem Umgebungslicht schaltet sich das Licht auch dann nicht EIN, wenn ein Bewegungssignal vorhanden ist.

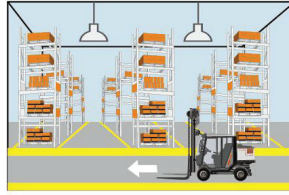

2. Bei ausreichendem Umgebungslicht schaltet der Sensor das Licht ein, wenn eine Bewegung erkannt wird.

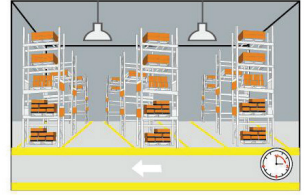

3. Nach Ablauf der Haltezeit schaltet der Sensor das Licht aus, wenn keine Bewegung erkannt wird.

2) 2-Stufen-Dimmfunktion (Standby-Zeit auf „+∞“ eingestellt)

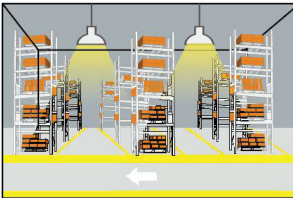

1. Wenn keine Bewegung erkannt wird, bleibt das Licht die ganze Zeit auf einem niedrigen Lichtniveau.

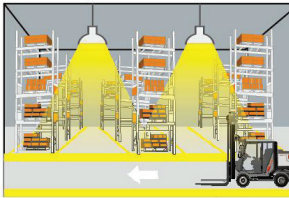

2. Wenn eine Bewegung erkannt wird, schaltet der Sensor das Licht auf 100% Helligkeit ein.

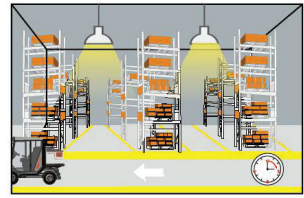

3. Nach Ablauf der Haltezeit dimmt der Sensor das Licht auf das derzeitige niedrige Lichtniveau, wenn keine Bewegung erkannt wird.

3) 3- Stufen-Dimmfunktion (Standby-Zeit auf "10s/1min/3min/5min/10min/30min" eingestellt)

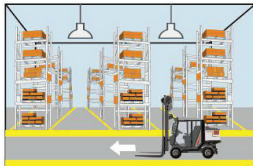

1. Bei ausreichendem Umgebungslicht wird das Licht auch dann nicht eingeschaltet, wenn ein Bewegungssignal vorhanden ist.

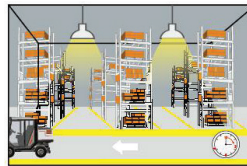

3. Nach Ablauf der Haltezeit dimmt der Sensor das Licht bei schlechten Lichtverhältnissen ab, wenn keine neue Bewegung erkannt wird.

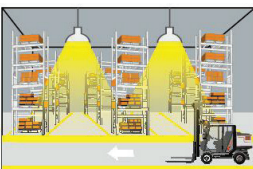

2. Bei ausreichendem Umgebungslicht schaltet der Sensor das Licht ein, wenn eine Bewegung erkannt wird.

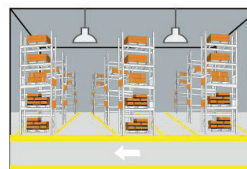

4. Nach Ablauf der Standby-Zeit schaltet der Sensor das Licht aus, wenn in der Erkennungszone keine Bewegung erkannt wird.

ABMESSUNGSDIAGRAMM

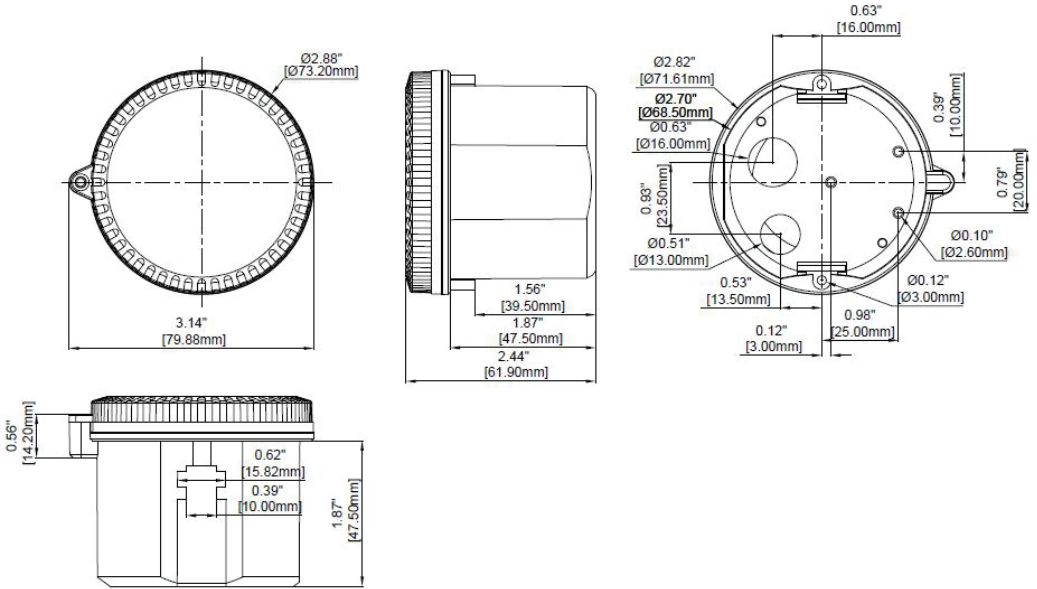

SCHALTPLAN

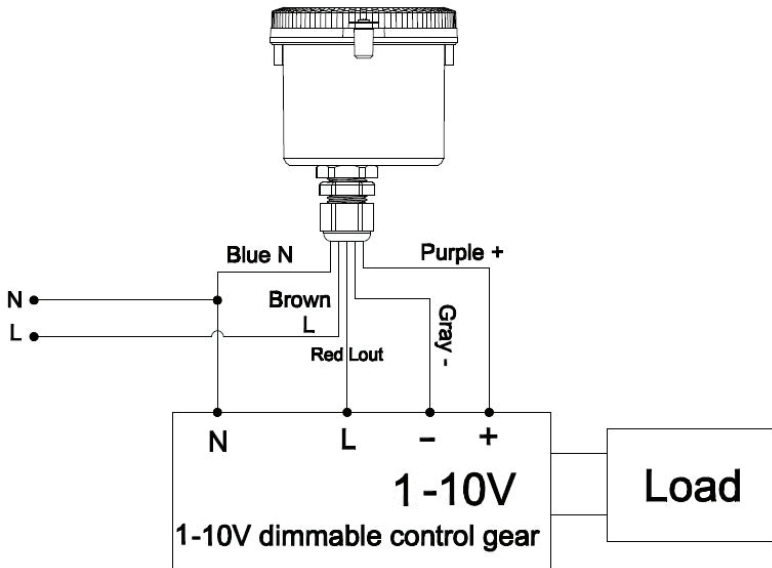

INSTALLATIONS DIAGRAMM

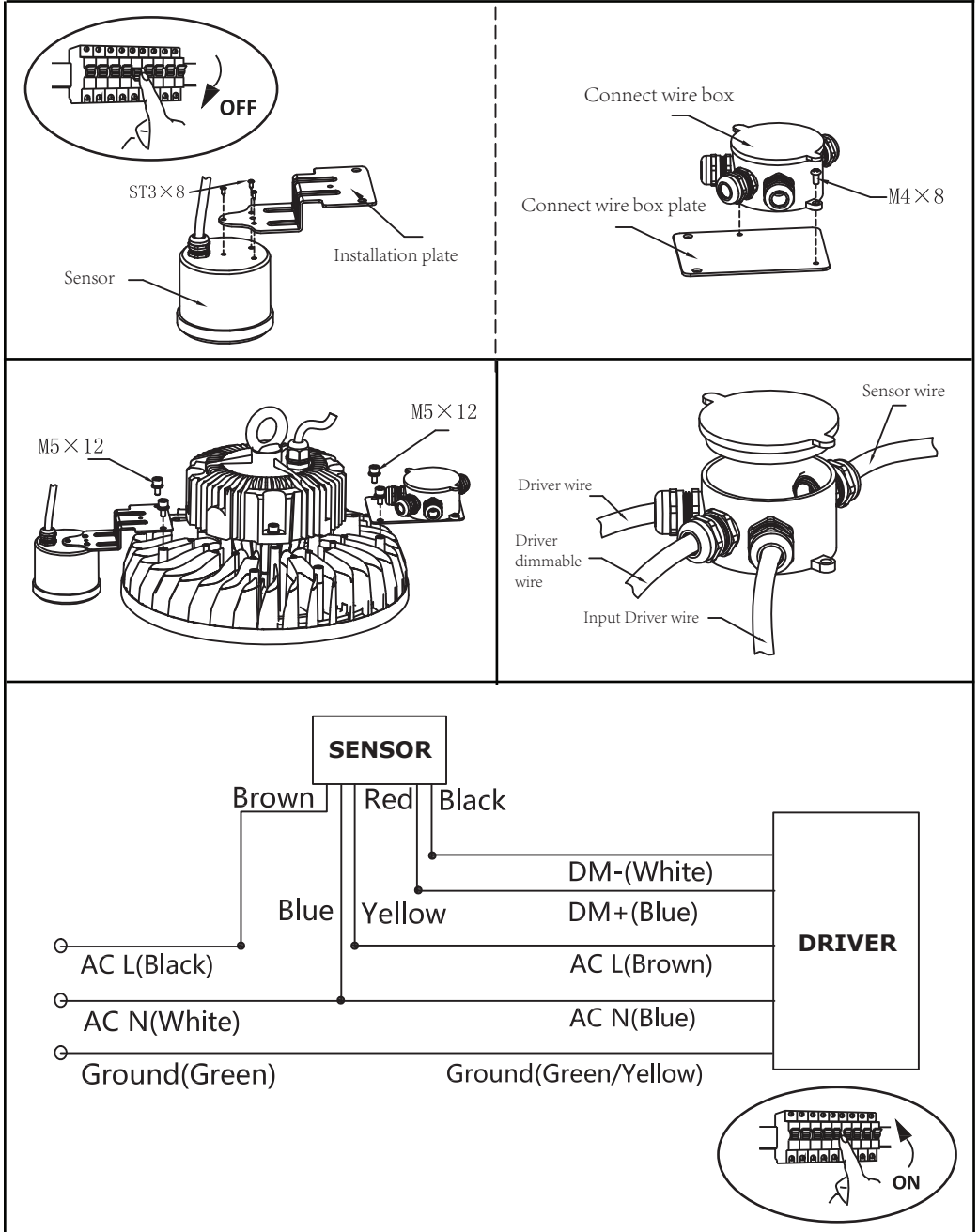

FUNKTIONSDIAGRAMM

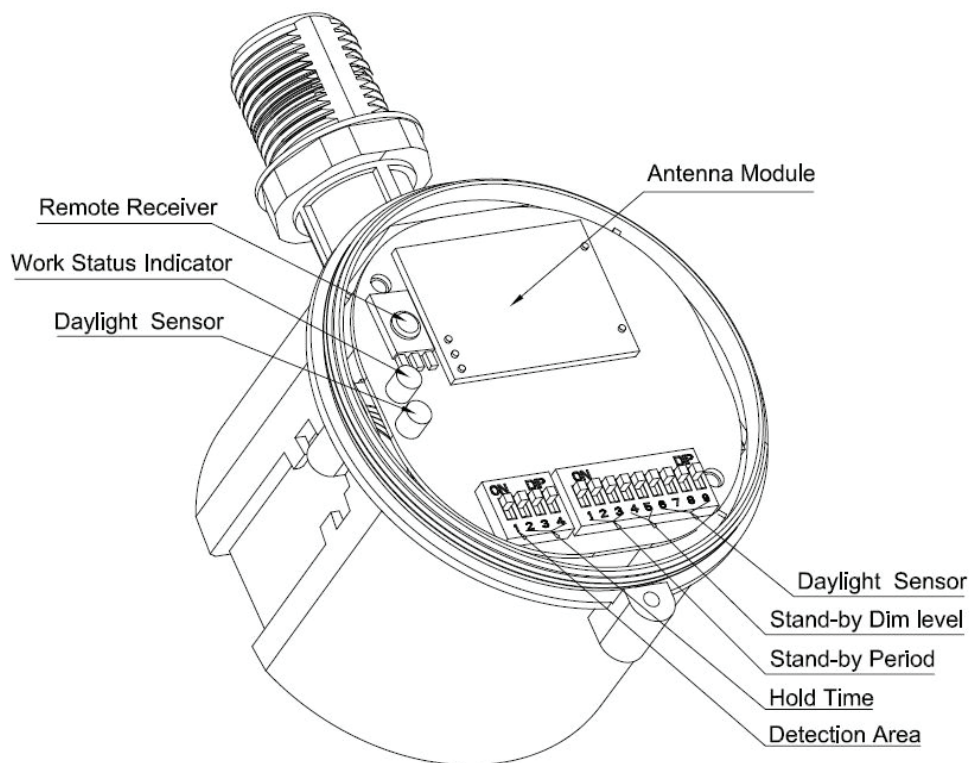

BEDIENELEMENTE

(HOLD TIME)

	2	3	4	
I	ON	ON	ON	5s
II	-	ON	ON	30s
III	ON	-	ON	1min
IV	-	-	ON	3min
V	ON	ON	-	20min
VI	-	-	-	30min

(STAND-BY PERIOD)

	1	2	3	
I	ON	ON	ON	0s
II	-	ON	ON	1min
III	ON	-	ON	3min
IV	-	-	ON	10min
V	ON	ON	-	30min
VI	-	-	-	+∞

(STAND-BY DIM LEVEL)

	4	5	%	1-10V
I	ON	ON	10%	1.4-1.6V
II	ON	-	20%	1.9-2.1V
III	-	ON	30%	2.9-3.1V
IV		-	50%	4.9-5.1V

(DAYLIGHT SENSOR)

	6	7	8	9	
I	ON	ON	ON	ON	5Lux
II	-	ON	ON	ON	15Lux
III	ON	-	ON	ON	30Lux
IV	-	-	ON	ON	50Lux
V	ON	ON	-	ON	100Lux
VI	ON	ON	ON	-	150Lux
VII	-	-	-	-	Disable*

(DETECTION AREA)

	1	
I	ON	100%
II	-	50%

DECKENMONTAGEDIAGRAMM

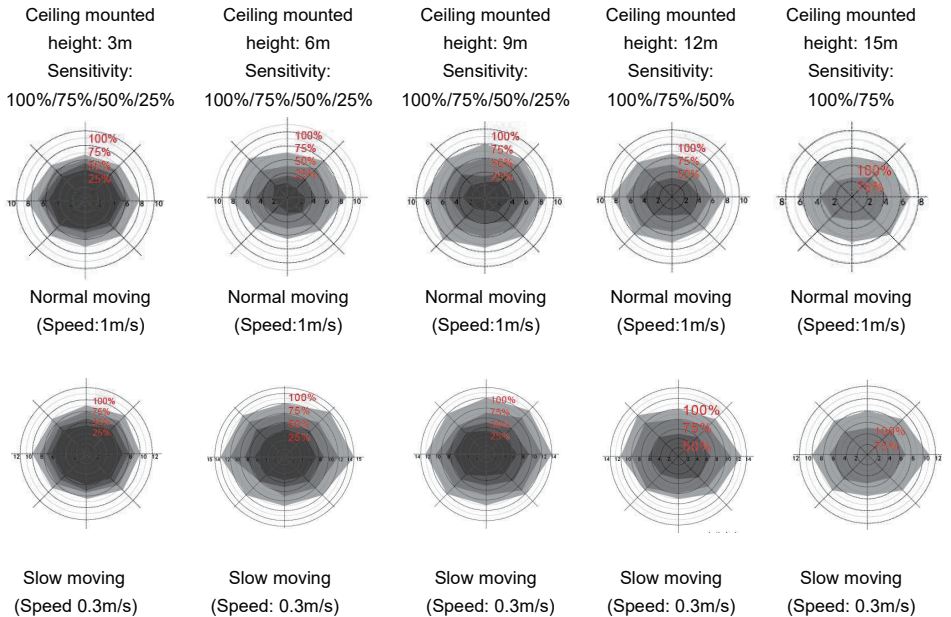

*Only 100%/75%/50% detection sensitivity is workable when installed at 10m & 15m mounting height. 25% sensitivity is not able to detect motion signal.

INITIALISIERUNG

1. Ein/Aus-Funktion /3-Stufen-Dimmfunktion:

Nach dem Einschalten schaltet der Sensor das Licht bei 100% Helligkeit automatisch ein. Nach 10 Sekunden wird das Licht ausgeschaltet. Während der Initialisierung kann der Sensor keine Bewegung erkennen.

2. 2-Stufen-Dimmfunktion:

Nach dem Einschalten schaltet der Sensor das Licht bei 100% Helligkeit automatisch ein. Nach 10 Sekunden wird das Licht auf eine niedrige Lichtstärke gedimmt (eingestellt durch Standby-Dimmstufe). Während der Initialisierung kann der Sensor keine Bewegung erkennen.

WERKSEINSTELLUNGEN

Erkennungsbereich: 100%, Haltezeit: 5 Sekunden, Standby-Zeit: 0 Sekunden, Standby-Dimmstufe: 10%, Tageslichtsensor: Deaktivieren

ANWENDUNGSHINWEIS

1) Der Sensor sollte von einem professionellen Elektriker installiert werden. Bitte schalten Sie die Stromversorgung aus, bevor Sie den DIP-Schalter installieren, verkabeln und dessen Einstellung ändern.

2) Der im Lampenschirm aus Kunststoff und Glas installierte Sensor wird eine verringerte Empfindlichkeit erweisen.

Mit jeder Erhöhung der Dicke um 3 mm wird die Empfindlichkeit um 20% verringert.

3) Die Dimmleistung kann für verschiedene 1-10V-Treiber unterschiedlich sein.

4) Die Lichtempfindlichkeitsschwelle gilt für eine Sonnenumgebung ohne Schatten und diffuse Reflexion des Umgebungslichts. Das Lux-Niveau in der Umgebung kann in verschiedenen Umgebungen, Wetter, Klima, Tageszeit und Jahreszeit unterschiedlich sein.

5) Die Parameter des Sensors müssen möglicherweise in verschiedenen Installationsumgebungen neu konfiguriert werden.

6) Dieser Sensor ist nur für den Innenbereich bestimmt. Bei Verwendung im Freien kann die Wasserbeständigkeit beeinträchtigt werden. Wind, Regen und sich bewegende Objekte verursachen falsche Auslösungen.

7) Der Abstand zwischen induktiven Sensoren sollte größer als 3 m sein.

8) Stellen Sie den Sensor nicht in der Nähe von Objekten mit hoher Dichte wie Metall, Glas, Betonwänden usw. auf, da dies zu Fehlauflösungen führen kann. Wenn der Sensor in einer Metalllampe, einer reflektierenden Metalloberfläche oder einer engen geschlossenen Umgebung installiert wird, wird die Mikrowelle wiederholt reflektiert und verursacht eine falsche Auslösung. Bitte reduzieren Sie die Empfindlichkeit oder wenden Sie sich an den Hersteller, um technischen Support zu erhalten.

9) Stellen Sie sicher, dass sich keine beweglichen Signale um den Sensor herum befinden, z. B. Lüfter, Gleichstrommotor, Abwasserrohr, Luftauslass usw. Der Sensor kann einen falschen Auslöser erzeugen.

10) Es wird empfohlen, 5 Proben vor der Massenanwendung des Sensors in einem neuen Beleuchtungsprojekt zu testen.

11) Aufgrund kontinuierlicher Verbesserungen kann der Inhalt dieser Anleitung ohne vorherige Ankündigung geändert werden.

INSTRUCCIONES DE INSTALACIÓN HIGHBAY SENSOR



5 YEARS
WARRANTY*

INTRODUCCIÓN Y GARANTÍA

Le agradecemos que ha elegido y adquirido la V-TAC. V-TAC le servirá del mejor modo posible. Pedimos que antes de comenzar la instalación lea atentamente las presentes instrucciones y las guarde en un lugar adecuado para consultas próximas. En caso de dudas o preguntas, póngase, por favor, en contacto con el representante o suministrador más cercano de quien ha comprado el producto. Él será debidamente instruido y dispuesto para atenderle de la mejor manera posible. La garantía tendrá una duración de 5 años, contados a partir de la fecha de la compra. La garantía no será aplicable a daños ocasionados por instalación incorrecta o gasto inhabitual. La empresa no otorgará garantía para daños de superficies de cualquier tipo generados por su eliminación e instalación incorrectas.

CUIDADO

1. Apague la alimentación y lea estas instrucciones antes de empezar la instalación.
2. Instalación solo por electricista certificado.



Este símbolo indica que este producto no debe desecharse con los residuos domésticos.



Precaución, riesgo de descarga eléctrica.

CARACTERÍSTICAS DE PRODUCTO

1. Voltaje de funcionamiento 100/277V AC, 50/60Hz
2. La altura máxima de instalación de la antena de microondas es 15 m, es adecuada para la instalación en la mayoría de los almacenes.
3. Tiene modos de alta y baja sensibilidad (para techos de metal, entornos de instalación reflectantes de metal) y operación con controlador de atenuación de LED de 1-10 V, función de atenuación de 2 o 3 niveles de fácil acceso.
4. Compatible con los modelos Highbay de V-TAC, VT-9-151 y VT-9-200

PARÁMETROS

Input	Operating Voltage Range	108-305V AC, 50Hz/60Hz
	DC Input Voltage	N/A
	Rated Voltage	100/277V AC, 50Hz/60Hz
	No-load Power	N/A
	Stand-by Power	<1W
Output	Surge Test	L-N: 1kV
	Working Mode	ON/OFF function, 1-10V step dimming
	Type of Load	Inductive or resistive Load
	Load Capacity	100VAC: 4A; 277VAC: 3A
	Current of Load	N/A
Dim Interface	Max. Surge Capacity	50A (50% I _{peak} , t _{width} =500uS, 230Vac full load, cold start);
		80A (50% I _{peak} , t _{width} =200uS, 230Vac, full load, cold start)
		< 50mA (Non-constant source)
	1-10V Dimming	10%(1.4-1.6V), 20%(1.9-2.1V), 30%(2.9-3.1V), 50% (4.9-5.1V)
	Synchronous Control	N/A
Sensor Parameters	High Low-level	N/A
	PWM Control	N/A
	Operating Frequency	5.8 GHz ±75 MHz, ISM Band.
	Transmitting power	0.5mW Max.
	Hold time	5s/30s/1min/3min/5min/10min/20min/30min
Others	Stand-by DIM Level	10%/20%/30%/50%
	Stand-by Period	0s/10s/1min/3min/5min/10min/30min/+∞
	Detection Area	25%/50%/75%/100%
	Daylight Sensor	5lux/15lux/30lux/50lux/100lux/150lux/Disable (Ambient light diffusion)
	Mounting Height	15m Max
	Detecting Angle	360°(ceiling mounting)
	Operating Environment	Operating Temperature
Storage Temperature		Temperature:-40 to +80; Humidity:10%-95% (non-condensing)
Others	Wiring	H05RR-F,5*18AWG exposed line length: 810-830mm
	Wiring Color	Sheath: blue, brown, red, purple, gray
	IP Rating	IP65
	Protection Class	Class II
	Installation	Independent
	Dimension	(ΦxH)72*59mm
Lifetime	50,000h @ Ta Full load	

Nota

1. "N/A" significa no disponible.
2. La zona de detección depende del volumen del objeto en movimiento y de la velocidad del movimiento. La zona de detección es probada por una persona con una altura de 165 cm y una velocidad de 0,5 m / s.

FUNCIONES

1) Función de ENCENDIDO/APAGADO (período de espera establecido en "0")

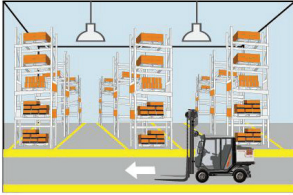

1. Con suficiente luz ambiental, la luz no se ENCENDERÁ incluso si hay una señal de movimiento.

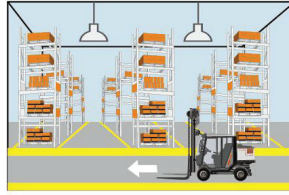

2. Con suficiente luz ambiental, el sensor enciende la luz al detectar movimiento.

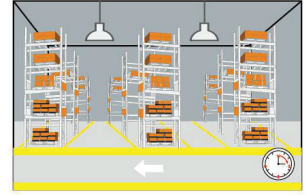

3. Una vez transcurrido el tiempo de espera, el sensor apaga la luz cuando no se detecta movimiento.

2) Función de atenuación de 2 niveles (período de espera establecido en "+∞")

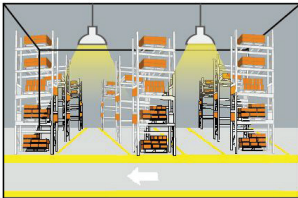

1. Si no se detecta movimiento, la luz permanecerá encendida en un nivel bajo de luz en todo momento.

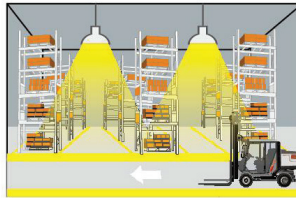

2. Al detecta movimiento, el sensor enciende la luz al 100% de brillo.

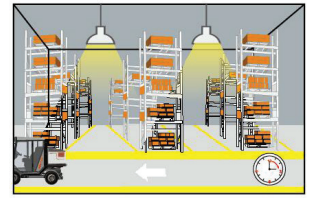

3. Una vez transcurrido el tiempo de espera, el sensor atenuará la luz al actual nivel bajo de luz en caso de que no se detecte movimiento.

3) Función de atenuación de 3 niveles (período de espera establecido en "10 segundos / 1 minuto / 3 minutos / 5 minutos / 10 minutos / 30 minutos")

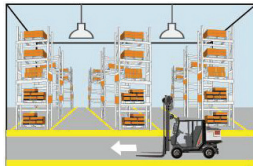

1. Con suficiente luz ambiental, la luz no se encenderá incluso si hay un señal de movimiento.

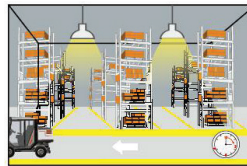

2. Con suficiente luz ambiental, el sensor enciende la luz al detectar movimiento.

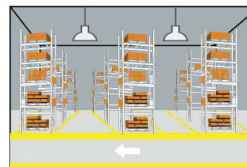

3. Una vez transcurrido el tiempo de retención, el sensor atenuará la luz a un bajo nivel de luz si no se detecta ningún movimiento nuevo.

4. Una vez transcurrido el período de espera, el sensor apaga la luz si no se detecta movimiento en el área de detección.

DIAGRAMA DE DIMENSIONES



DIAGRAMA DE CABLEADO



DIAGRAMA DE INSTALACIÓN

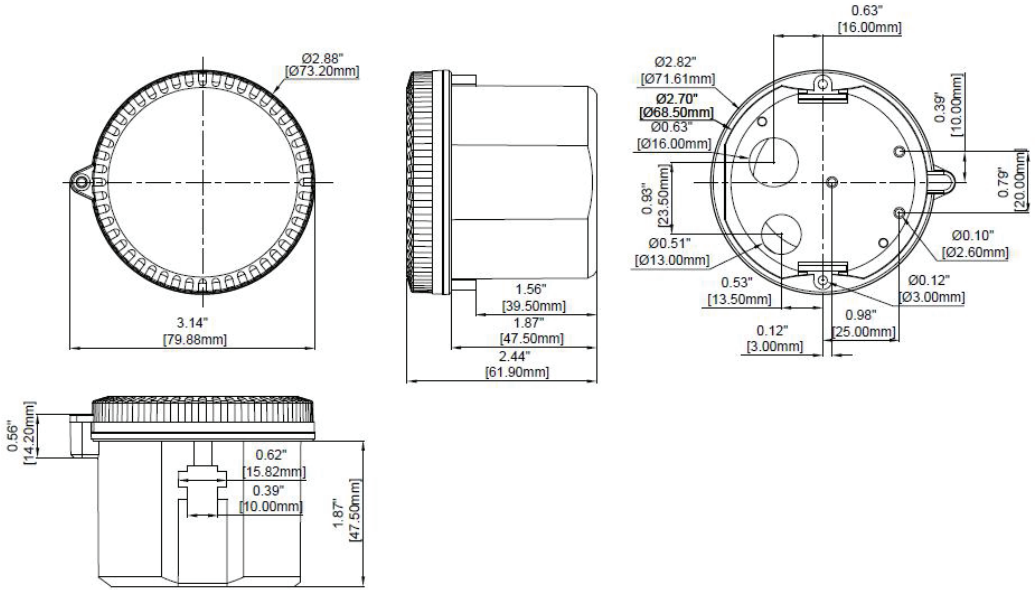

DIAGRAMA DE FUNCIÓN

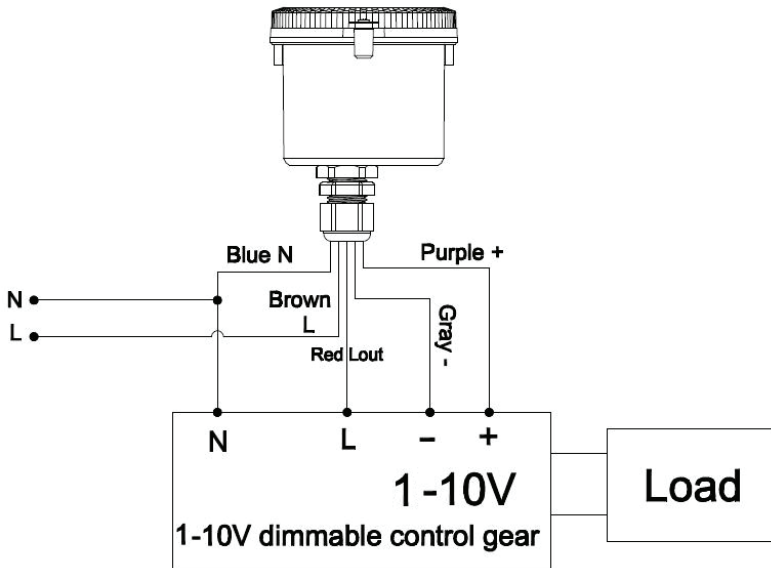

CONTROLES

(HOLD TIME)

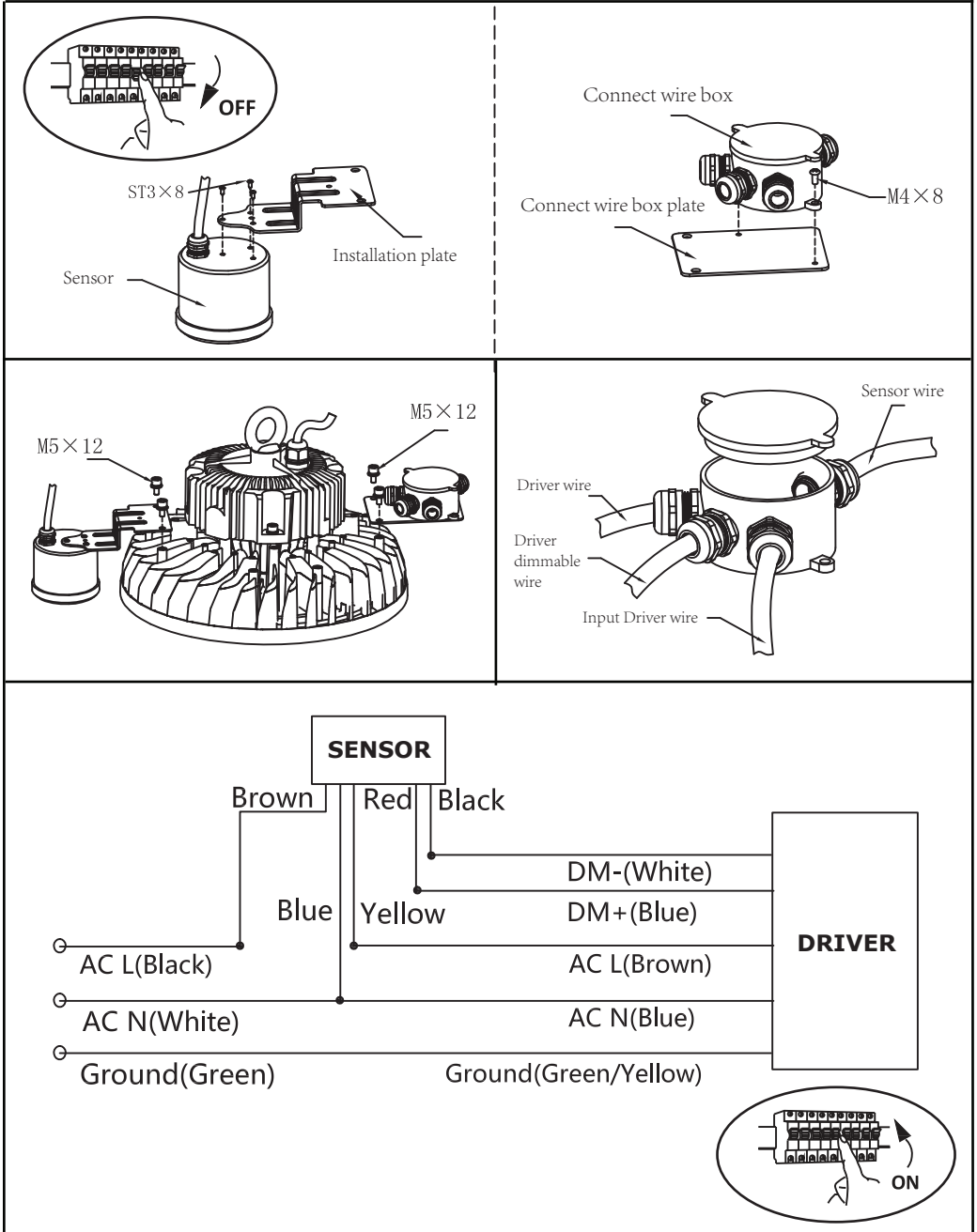
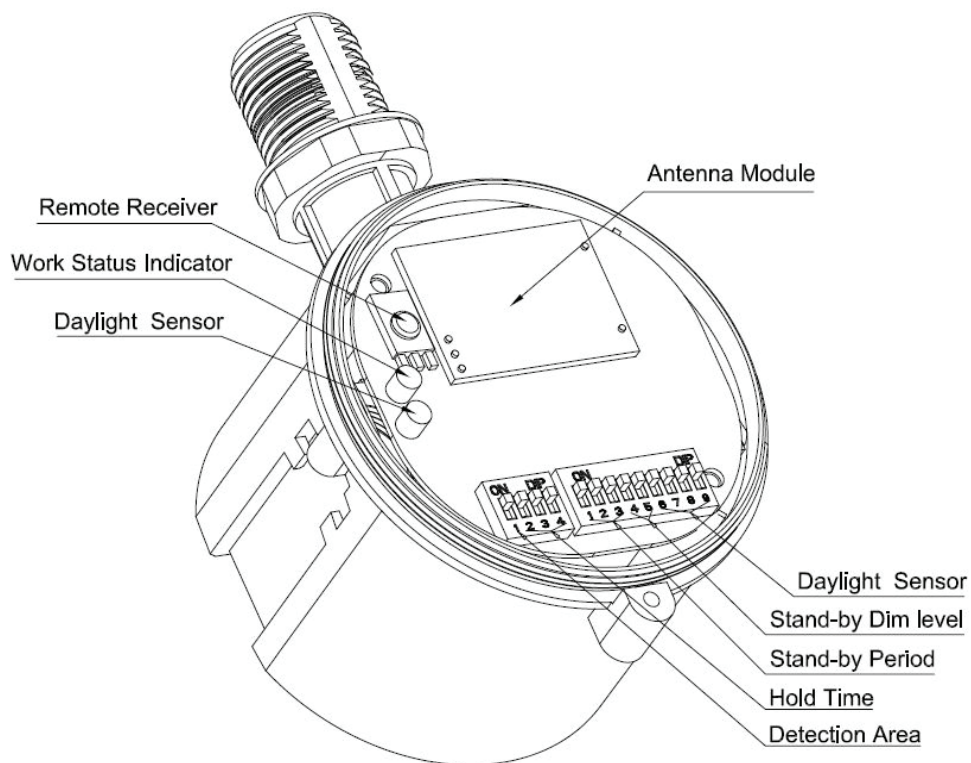
	2	3	4	
I	ON	ON	ON	5s
II	-	ON	ON	30s
III	ON	-	ON	1min
IV	-	-	ON	3min
V	ON	ON	-	20min
VI	-	-	-	30min

(STAND-BY PERIOD)

	1	2	3	
I	ON	ON	ON	0s
II	-	ON	ON	1min
III	ON	-	ON	3min
IV	-	-	ON	10min
V	ON	ON	-	30min
VI	-	-	-	+∞

(STAND-BY DIM LEVEL)

	4	5	%	1-10V
I	ON	ON	10%	1.4-1.6V
II	ON	-	20%	1.9-2.1V
III	-	ON	30%	2.9-3.1V
IV		-	50%	4.9-5.1V

(DETECTION AREA)

	1	
I	ON	100%
II	-	50%

(DAYLIGHT SENSOR)

	6	7	8	9	
I	ON	ON	ON	ON	5Lux
II	-	ON	ON	ON	15Lux
III	ON	-	ON	ON	30Lux
IV	-	-	ON	ON	50Lux
V	ON	ON	-	ON	100Lux
VI	ON	ON	ON	-	150Lux
VII	-	-	-	-	Disable*

DIAGRAMA DE INSTALACIÓN EN TECHO

Ceiling mounted
height: 3m
Sensitivity:
100%/75%/50%/25%

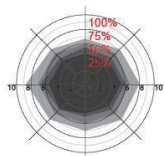

Normal moving
(Speed:1m/s)

Ceiling mounted
height: 6m
Sensitivity:
100%/75%/50%/25%

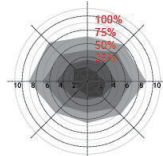

Normal moving
(Speed:1m/s)

Ceiling mounted
height: 9m
Sensitivity:
100%/75%/50%/25%

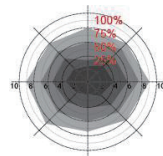

Normal moving
(Speed:1m/s)

Ceiling mounted
height: 12m
Sensitivity:
100%/75%/50%

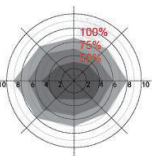

Normal moving
(Speed:1m/s)

Ceiling mounted
height: 15m
Sensitivity:
100%/75%

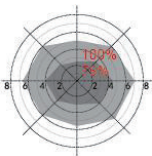

Normal moving
(Speed:1m/s)

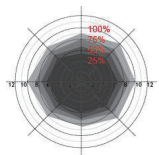

Slow moving
(Speed 0.3m/s)

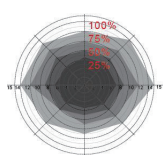

Slow moving
(Speed: 0.3m/s)

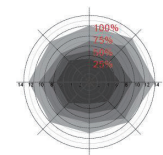

Slow moving
(Speed: 0.3m/s)

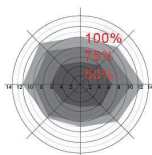

Slow moving
(Speed: 0.3m/s)

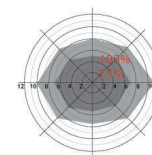

Slow moving
(Speed: 0.3m/s)

*Only 100%/75%/50% detection sensitivity is workable when installed at 10m & 15m mounting height. 25% sensitivity is not able to detect motion signal.

INICIALIZACIÓN

1. Función de encendido/apagado/función de atenuación de 3 niveles:

Después de estar encendido, el sensor enciende automáticamente la iluminación al 100% de brillo. Después de 10 segundos, apaga la luz. Durante la inicialización, el sensor no puede detectar movimiento.

2. Función de atenuación de 2 niveles:

Después de estar encendido, el sensor enciende automáticamente la iluminación al 100% de brillo. Después de 10 segundos, atenúa la luz a un bajo nivel de luz (establecido por el nivel de atenuación en el modo de espera). Durante la inicialización, el sensor no puede detectar movimiento.

AJUSTES DE FÁBRICA

Zona de detección: 100%, tiempo de retención: 5S, período de espera: 0s, nivel de atenuación en espera: 10%, sensor de luz diurna: Parar

NOTIFICACIÓN DE APLICACIÓN

- 1) El sensor debe ser instalado por un electricista profesional. Apague la alimentación antes de la instalación, cableado, cambio de la configuración del interruptor DIP.
- 2) El sensor, que está instalado en la pantalla de plástico y vidrio, reduce la sensibilidad. Por cada aumento de espesor de 3 mm, la sensibilidad se reduce en un 20%.
- 3) Los resultados de la función de atenuación pueden diferir para los diferentes controladores 1-10v.
- 4) El umbral de sensibilidad a la luz es en un entorno soleado, sin sombras y sin reflexión difusa de la luz ambiental. El nivel de iluminación ambiental puede ser diferente en diferentes entornos, condiciones atmosféricas, climas, hora del día y estación del año.
- 5) Puede ser necesario reconfigurar los parámetros del sensor en diferentes tipos de entornos de instalación.
- 6) Este sensor es solo para uso en interiores. Afectará la acción impermeable para uso en exteriores. El viento, la lluvia y los objetos en movimiento provocan una activación innecesaria.
- 7) La distancia entre todo tipo de sensores inductivos debe ser superior a 3 m.
- 8) No coloque el sensor cerca de objetos de alta densidad, como paredes de metal, vidrio, hormigón, ya que es posible que se provoque una activación innecesaria. Cuando el sensor se instala en una luz de metal, superficies de metal reflectantes o un espacio cerrado y estrecho, las microondas se reflejarán repetidamente y provocarán una activación innecesaria. Por favor, reduzca la sensibilidad o póngase en contacto con el fabricante para obtener asistencia técnica.
- 9) Asegúrese de que no haya señales en movimiento alrededor del sensor, como ventilador, unidad de CC, tubería de alcantarillado, salida de aire, etc., el sensor puede generar una activación innecesaria.
- 10) Le recomendamos que pruebe 5 muestras antes de la aplicación masiva del sensor en un nuevo proyecto de iluminación.
- 11) Debido a la mejora continua, el contenido de estas instrucciones está sujeto a cambios sin previo aviso.

INSTRUCTIONS D'INSTALLATION HIGHBAY SENSOR



5 YEARS
WARRANTY*

INTRODUCTION & GARANTIE

Merci d'avoir choisi et acheté un produit à V-TAC. V-TAC vous offrira le meilleur. Veuillez lire attentivement ces instructions avant de commencer l'installation et conservez ce manuel à portée de main pour référence ultérieure. Si vous avez d'autres questions, veuillez contacter notre distributeur ou le fournisseur local auprès duquel vous avez acheté le produit. Ils sont formés et prêts à vous servir au mieux. La garantie est valable pour une période de 5 ans à compter de la date d'achat. La garantie ne s'applique pas à des dommages causés par une installation incorrecte ou une usure anormale. La société ne donne aucune garantie pour des dommages causés à une surface en raison d'un enlèvement et d'une installation incorrects du produit.

ATTENTION

1. Veuillez mettre hors tension et lire ces instructions avant de commencer l'installation.
2. Installation par électricien certifié



Ce marquage indique que ce produit ne doit pas être éliminé avec d'autres déchets ménagers



Attention, risque de choc électrique.

CARACTÉRISTIQUES DU PRODUIT

1. Tension de fonctionnement 100/277V AC, 50/60Hz
2. La hauteur de montage de l'antenne micro-ondes est de 15 m maximum, ce qui permet de l'installer dans la plupart des entrepôts.
3. Prend en charge les modes haute et basse sensibilité (pour les plafonds métalliques, les environnements de montage avec réflecteurs métalliques) et fonctionne avec un pilote de LED 1-10V gradable, fonction de gradation facile à réaliser en 2 ou 3 étapes.
4. Compatible avec les modèles Highbay VT-9-151 et VT-9-200 de V-TAC

PARAMÈTRES

Input	Operating Voltage Range	108-305V AC, 50Hz/60Hz
	DC Input Voltage	N/A
	Rated Voltage	100/277V AC, 50Hz/60Hz
	No-load Power	N/A
	Stand-by Power	<1W
Output	Surge Test	L-N: 1kV
	Working Mode	ON/OFF function, 1-10V step dimming
	Type of Load	Inductive or resistive Load
	Load Capacity	100VAC: 4A; 277VAC: 3A
	Current of Load	N/A
Dim Interface	Max. Surge Capacity	50A (50% Ipeak, twidth =500uS, 230Vac full load, cold start);
		80A (50% Ipeak, twidth =200uS, 230Vac, full load, cold start)
		< 50mA (Non-constant source)
	1-10V Dimming	10%(1.4-1.6V), 20%(1.9-2.1V), 30%(2.9-3.1V), 50% (4.9-5.1V)
Dim Interface	Synchronous Control	N/A
	High Low-level	N/A
	PWM Control	N/A
Sensor Parameters	Operating Frequency	5.8 GHz ±75 MHz, ISM Band.
	Transmitting power	0.5mW Max.
	Hold time	5s/30s/1min/3min/5min/10min/20min/30min
	Stand-by DIM Level	10%/20%/30%/50%
	Stand-by Period	0s/10s/1min/3min/5min/10min/30min/+∞
	Detection Area	25%/50%/75%/100%
	Daylight Sensor	5lux/15lux/30lux/50lux/100lux/150lux/Disable (Ambient light diffusion)
	Mounting Height	15m Max
Operating Environment	Detecting Angle	360°(ceiling mounting)
	Operating Temperature	-35 to +55
Others	Storage Temperature	Temperature:-40 to +80; Humidity:10%-95% (non-condensing)
	Wiring	H05RR-F,5*18AWG exposed line length: 810-830mm
	Wiring Color	Sheath: blue, brown, red, purple, gray
	IP Rating	IP65
	Protection Class	Class II
	Installation	Independent
	Dimension	(ΦxH)72*59mm
Lifetime	50,000h @ Ta Full load	

Note

1. «N/A» signifie non disponible.
2. La zone de détection dépend du volume de l'objet en mouvement et de la vitesse de mouvement. La zone de détection est testée par une personne de 165 cm de haut et la vitesse de marche est de 0,5 m/s

FONCTIONS

1) Fonction ON/OFF (période de veille réglée sur «0»)

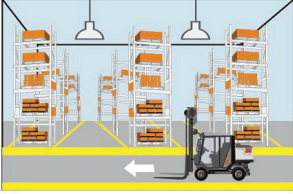

1. Avec une lumière ambiante suffisante, la lumière ne s'allumera pas même en présence d'un signal de mouvement.

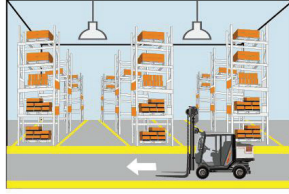

2. Lorsque la lumière ambiante est suffisante, le capteur allume la lumière lorsqu'un mouvement est détecté.

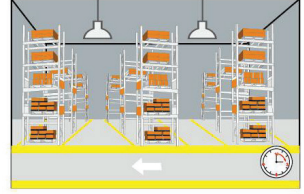

3. Après l'écoulement du temps d'attente, le capteur éteint la lumière lorsqu'aucun mouvement n'est détecté.

2) Fonction de gradation en 2 étapes (la période de veille doit être réglée sur «+∞»)

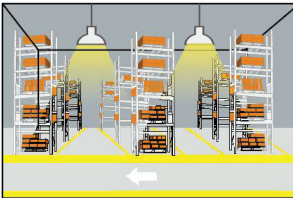

1. Si aucun mouvement n'est détecté, la lumière restera toujours à un niveau bas.

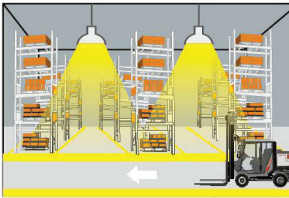

2. Lorsqu'un mouvement est détecté, le capteur allume la lumière à 100 % de sa luminosité.

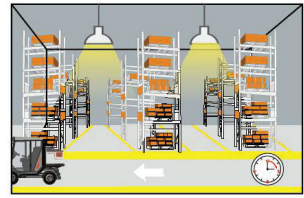

3. Après l'écoulement du temps d'attente, le capteur diminue la lumière au niveau de faible luminosité si aucun mouvement n'est détecté.

3) Fonction de gradation en 3 étapes (la période de veille doit être réglée sur «10s/1min/3min/5min/10min/30min»)

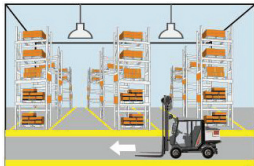

1. Avec une lumière ambiante suffisante, la lumière ne sera pas allumée même si un signal de mouvement est présent.

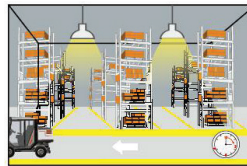

2. Lorsque la lumière ambiante est suffisante, le capteur allume la lumière lorsqu'un mouvement est détecté.

3. Après l'écoulement du temps d'attente, le capteur diminue la lumière au niveau de la lumière faible si aucun nouveau mouvement n'est détecté.

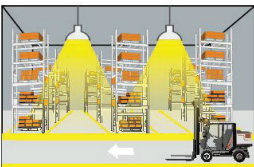

4. Après l'expiration de la période de veille, le capteur éteint la lumière si aucun mouvement n'est détecté dans la zone de détection.

DIAGRAMME DES DIMENSIONS



DIAGRAMME DE CÂBLAGE



DIAGRAMME D'INSTALLATION

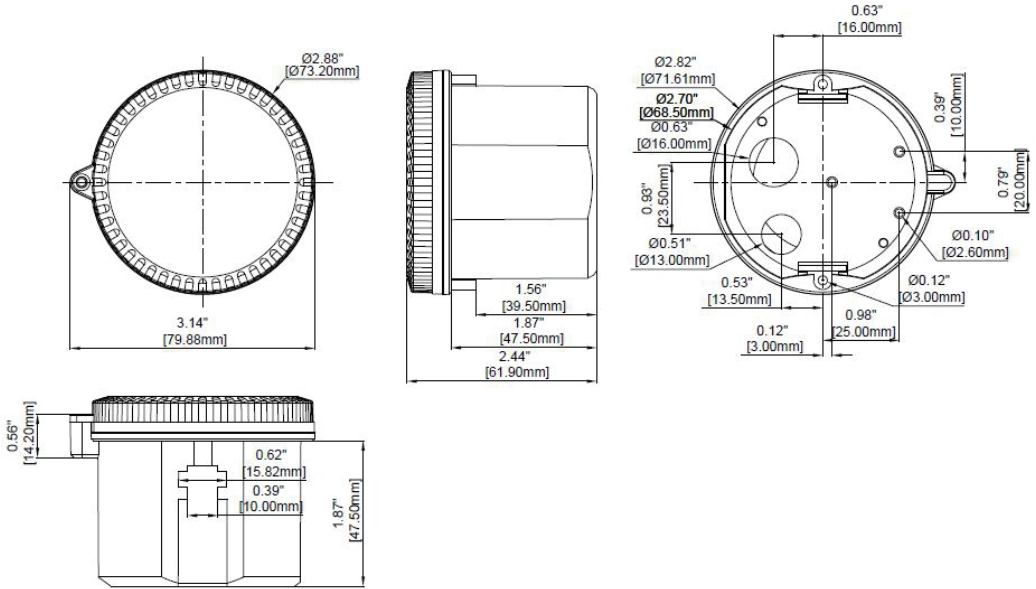

DIAGRAMME DE FONCTIONNEMENT

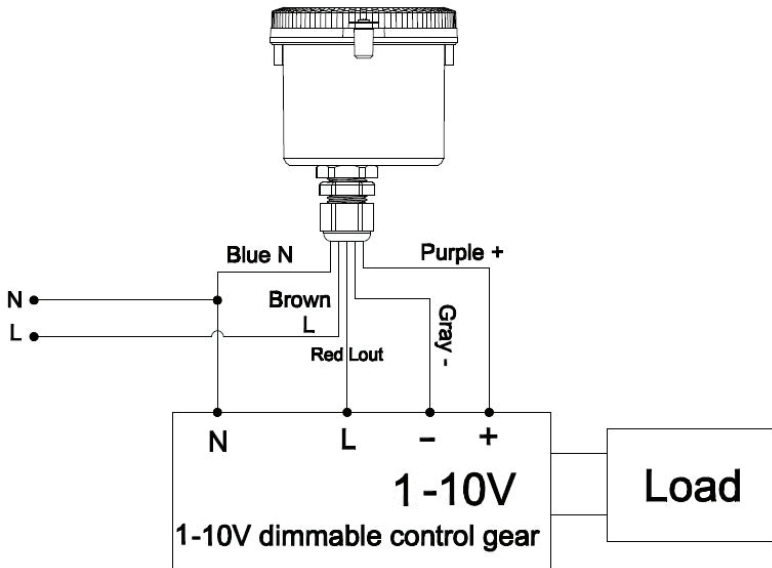

CONTRÔLES

(HOLD TIME)

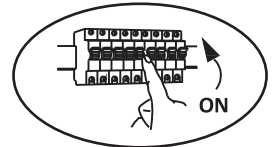
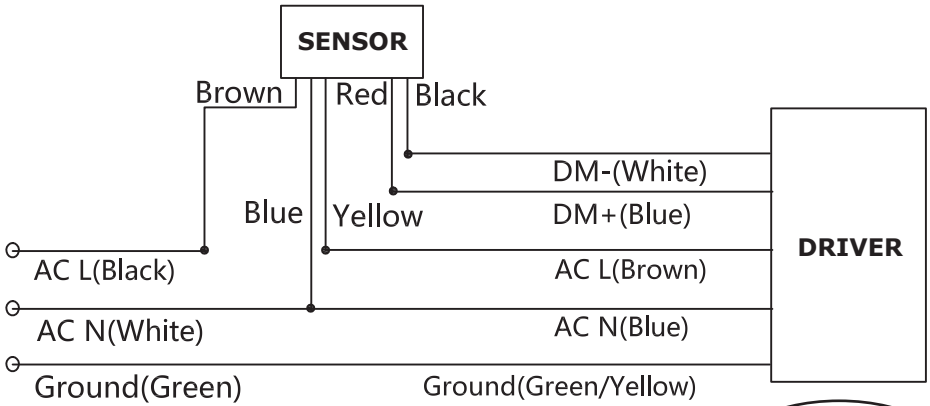
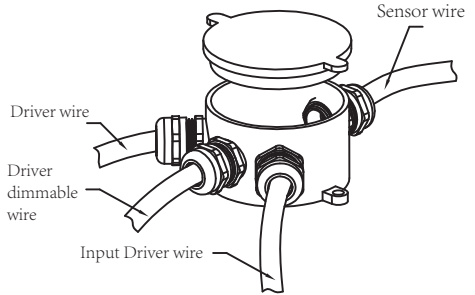
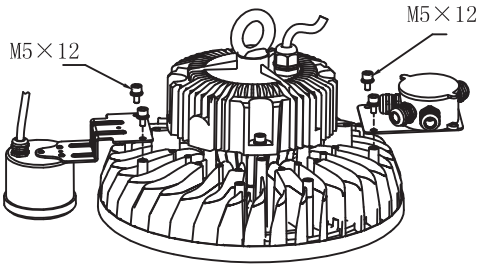
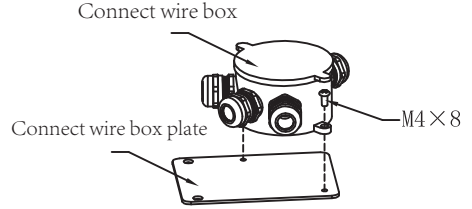
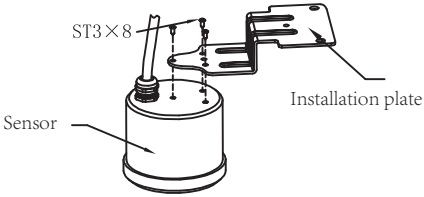
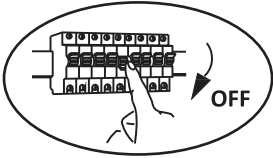
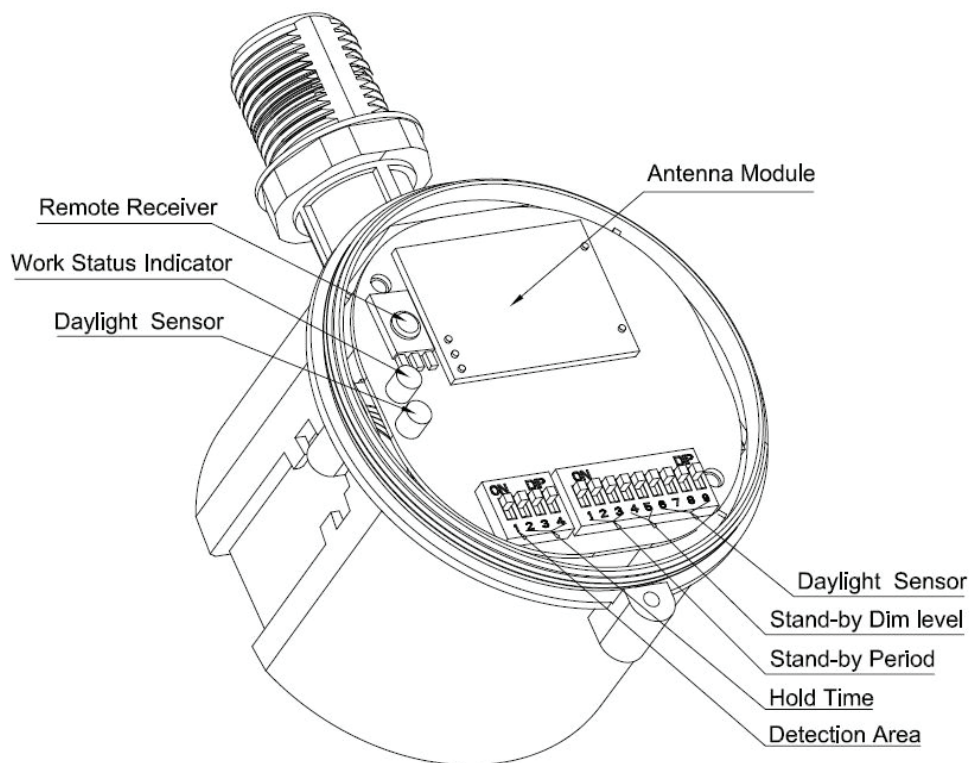
	2	3	4	
I	ON	ON	ON	5s
II	-	ON	ON	30s
III	ON	-	ON	1min
IV	-	-	ON	3min
V	ON	ON	-	20min
VI	-	-	-	30min

(STAND-BY PERIOD)

	1	2	3	
I	ON	ON	ON	0s
II	-	ON	ON	1min
III	ON	-	ON	3min
IV	-	-	ON	10min
V	ON	ON	-	30min
VI	-	-	-	+∞

(STAND-BY DIM LEVEL)

	4	5	%	1-10V
I	ON	ON	10%	1.4-1.6V
II	ON	-	20%	1.9-2.1V
III	-	ON	30%	2.9-3.1V
IV		-	50%	4.9-5.1V

(DAYLIGHT SENSOR)

	6	7	8	9	
I	ON	ON	ON	ON	5Lux
II	-	ON	ON	ON	15Lux
III	ON	-	ON	ON	30Lux
IV	-	-	ON	ON	50Lux
V	ON	ON	-	ON	100Lux
VI	ON	ON	ON	-	150Lux
VII	-	-	-	-	Disable*

(DETECTION AREA)

	1	
I	ON	100%
II	-	50%

DIAGRAMME DE MONTAGE AU PLAFOND

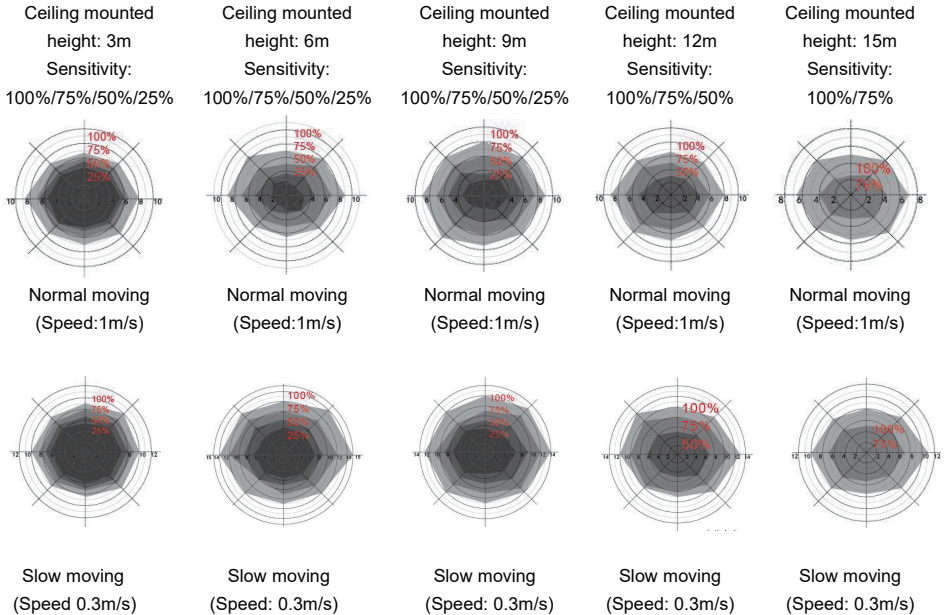

*Only 100%/75%/50% detection sensitivity is workable when installed at 10m & 15m mounting height. 25% sensitivity is not able to detect motion signal.

INITIALISATION

1. Fonction marche/arrêt /fonction de gradation en 3 étapes:

Après la mise sous tension, le capteur allume automatiquement la lumière à 100 % de sa luminosité. Après 10 secondes, il éteint la lumière. Pendant l'initialisation, le capteur n'est pas capable de détecter les mouvements.

2. Fonction de gradation en 2 étapes:

Après la mise sous tension, le capteur allume automatiquement la lumière à 100 % de sa luminosité. Après 10 secondes, il réduit la lumière à un faible niveau d'éclairage (défini par le niveau d'éclairage de veille). Pendant l'initialisation, le capteur n'est pas capable de détecter un mouvement.

RÉGLAGE EN USINE

Zone de détection: 100 %, temps d'attente: 5 s, période d'attente: 0 s, Niveau de luminosité en veille: 10 %, Capteur de lumière du jour: Désactiver

AVIS D'APPLICATION

- 1) Le capteur doit être installé par un électricien professionnel. Veuillez couper le courant avant de l'installer, de le câbler, de modifier le réglage du commutateur DIP.
- 2) Le capteur qui a été installé dans l'abat-jour en plastique et en verre réduira la sensibilité. Pour chaque augmentation de 3 mm d'épaisseur, la sensibilité sera réduite de 20 %.
- 3) Les performances de gradation peuvent être différentes selon les conducteurs 1-10v.
- 4) Le seuil de sensibilité à la lumière se situe dans un environnement ensoleillé, sans ombre et avec une réflexion diffuse de la lumière ambiante. Le niveau d'éclairage ambiant peut être différent selon l'environnement, le temps, le climat, l'heure et la saison.
- 5) Les paramètres du capteur peuvent devoir être reconfigurés dans différents environnements d'installation.
- 6) Ce capteur est destiné à un usage intérieur uniquement. Il affectera l'effet d'étanchéité pour une utilisation extérieure. Le vent, la pluie et les objets en mouvement provoqueront de faux déclenchements.
- 7) La distance entre tout capteur inductif doit être supérieure à 3 m.
- 8) Ne placez pas le capteur à proximité d'objets à haute densité tels que des murs en métal, en verre, en béton, etc. Lorsque le capteur est installé dans une lampe métallique, une surface métallique réfléchissante ou un environnement fermé étroit, les micro-ondes seront réfléchies de manière répétée et provoqueront un faux déclenchement. Veuillez réduire la sensibilité ou contacter le fabricant pour obtenir une assistance technique.
- 9) Veuillez vous assurer qu'il n'y a pas de signaux mobiles autour du capteur, tels que ventilateur, moteur à courant continu, tuyau d'égout, sortie d'air, etc., le capteur peut générer un faux déclenchement.
- 10) Il vous est conseillé de tester 5 échantillons avant d'appliquer en masse le capteur dans un nouveau projet d'éclairage.
- 11) En raison de l'amélioration continue, le contenu de cette instruction peut être modifié sans préavis.

UPUTE ZA UGRADNJU HIGHBAY SENSOR



5 YEARS
WARRANTY*

UVOD I JAMSTVO

Hvala vam, što ste odabrali i kupili tvrtke Vi-Tek (V-TAC). Vi-Tek (V-TAC) će vam poslužiti na najbolji mogući način. Molimo, pažljivo pročitajte ove upute prije instalacije i spremite upute za buduću uporabu. Ako imate dodatnih pitanja, molimo obratite se našem prodavaču ili lokalnom trgovcu gdje ste kupili ovaj proizvod. Oni su osposobljeni i spremni vam pomognu na najbolji način. Jamstvo za ovaj proizvod vrijedi za razdoblje od 5 godine, računajući od dana kupnje. Jamstvo se ne odnosi na štetu, nastalu nepravilnom ugradnjom ili neuobičajenim habanjem. Tvrtka ne jamči za štete koje nastanu po bilo kojoj površini proizvoda, zbog nepravilne demontaže odnosno i ugradnje proizvoda.

OPREZ

1. Molimo pročitajte ove upute i isključite napajanje prije početka ugradnje.
2. Ugradnju može obaviti samo stručni električar



Ova oznaka ukazuje da se ovaj proizvod ne smije odlagati s drugim kućnim otpadom.



Oprez, rizik od električnog udara.

KARAKTERISTIKE PROIZVODA

1. Radni napon 100/277V AC, 50/60Hz
2. Visina ugradnje mikrovalne antene je maksimalno 15 m, pogodno za ugradnju u većinu skladišta.
3. Podržava način rada visoke osjetljivosti i niske osjetljivosti (za metalne stropove, metalni reflektorski nosači) i rad s 1-10V LED dimerom za zatamnjivanje, uz lako postizanje funkcije dvostupanjskog ili trostupanjskog zatamnjivanja.
4. Kompatibilan je s Highbay modelima Vib-Tech VT-9-151 i VT-9-200

PARAMETRI

Input	Operating Voltage Range	108-305V AC, 50Hz/60Hz
	DC Input Voltage	N/A
	Rated Voltage	100/277V AC, 50Hz/60Hz
	No-load Power	N/A
	Stand-by Power	<1W
Output	Surge Test	L-N: 1kV
	Working Mode	ON/OFF function, 1-10V step dimming
	Type of Load	Inductive or resistive Load
	Load Capacity	100VAC: 4A; 277VAC: 3A
	Current of Load	N/A
Dim Interface	Max. Surge Capacity	50A (50% Ipeak, twidth =500uS, 230Vac full load, cold start);
		80A (50% Ipeak, twidth =200uS, 230Vac, full load, cold start)
	1-10V Dimming	< 50mA (Non-constant source) 10%(1.4-1.6V), 20%(1.9-2.1V), 30%(2.9-3.1V), 50% (4.9-5.1V)
	Synchronous Control	N/A
Sensor Parameters	High Low-level	N/A
	PWM Control	N/A
	Operating Frequency	5.8 GHz \pm 75 MHz, ISM Band.
Operating Environment	Transmitting power	0.5mW Max.
	Hold time	5s/30s/1min/3min/5min/10min/20min/30min
	Stand-by DIM Level	10%/20%/30%/50%
	Stand-by Period	0s/10s/1min/3min/5min/10min/30min/+ ∞
	Detection Area	25%/50%/75%/100%
	Daylight Sensor	5lux/15lux/30lux/50lux/100lux/150lux/Disable (Ambient light diffusion)
	Mounting Height	15m Max
	Detecting Angle	360°(ceiling mounting)
Others	Operating Temperature	-35 to +55
	Storage Temperature	Temperature:-40 to +80; Humidity:10%-95% (non-condensing)
Others	Wiring	H05RR-F,5*18AWG exposed line length: 810-830mm
	Wiring Color	Sheath: blue, brown, red, purple, gray
	IP Rating	IP65
	Protection Class	Class II
	Installation	Independent
	Dimension	(Φ xH)72*59mm
Lifetime	50,000h @ Ta Full load	

Napomena

1. "N/A" znači da nije dostupan.
2. Zona otkrivanja ovisi o volumenu pokretnog predmeta i brzini kretanja. Zona otkrivanja testira se osobom visine 165 cm i brzinom kretanja 0,5 m/s.

FUNKCIJE

1) Funkcije UKLJUČIVANJA/ISKLUČIVANJA (vrijeme mirovanja postavljeno je na "0")

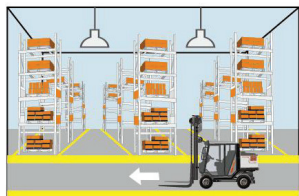

1. Kod dovoljne razine ambijentalne svjetlosti, osvjetljenje se **NEĆE UKLJUČITI** čak i ako je registriran pokret.

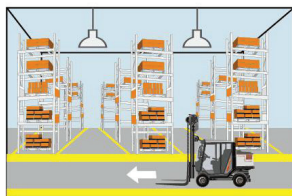

2. Kod dovoljne razine ambijentalne svjetlosti, senzor uključuje osvjetljenje nakon registriranog pokreta.

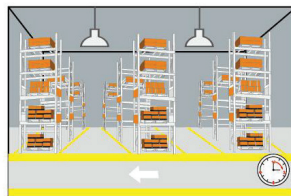

3. Nakon isteka vremena mirovanja, senzor isključuje osvjetljenje kada nije registriran pokret.

2) 2-stupanjska funkcija zatamnjenja (vrijeme mirovanja postavljeno je na "+ ∞")

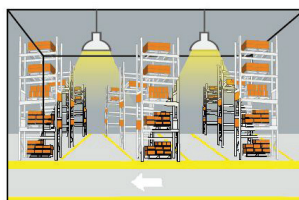

1. Ako se ne registrira pokret, osvjetljenje ostaje uključeno tijekom cijelog vremena pri slabom svjetlu.

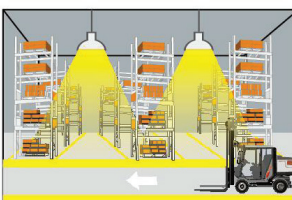

2. Ako se registrira pokret, senzor uključuje osvjetljenje na 100% jačine svjetlosti.

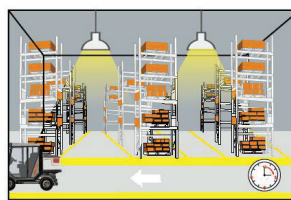

3. Nakon isteka vremena mirovanja, senzor će prigušiti osvjetljenje do trenutne slabe razine svjetlosti, u slučaju da se ne registrira pokret.

3) 3-stupanjska funkcija zatamnjenja (vrijeme mirovanja postavljeno je na "10 sekundi / 1 minuta / 3 minute / 5 minuta / 10 minuta / 30 minuta")

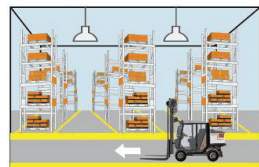

1. Kod dovoljne razine ambijentalne svjetlosti, osvjetljenje se neće uključiti čak i ako je registriran pokret.

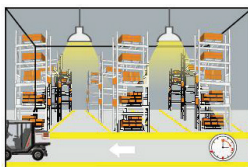

3. Nakon isteka vremena mirovanja, senzor zatamnjuje osvjetljenje do niske razine svjetlosti, kada nije registriran novi pokret.

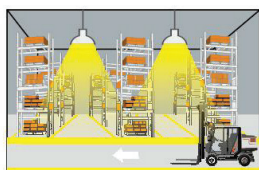

2. Kod dovoljne razine ambijentalne svjetlosti, senzor uključuje osvjetljenje nakon registriranog pokreta.

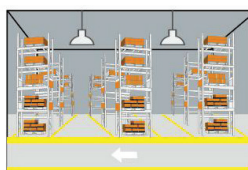

4. Nakon isteka vremena mirovanja, senzor isključuje osvjetljenje kada nije registriran novi pokret.

DIAGRAM DIMENZIJA

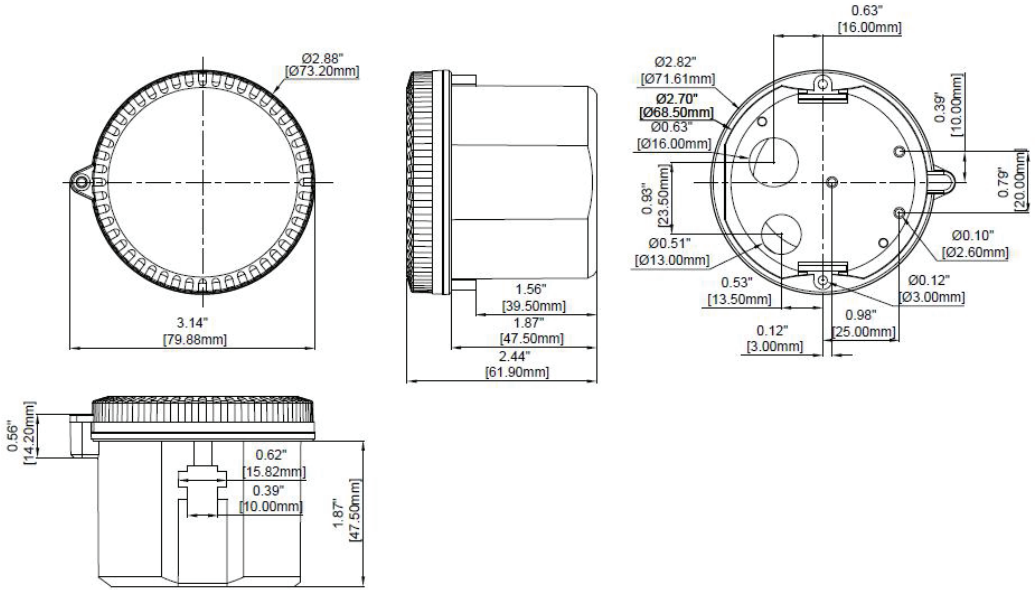

DIJAGRAM OŽIČENJA

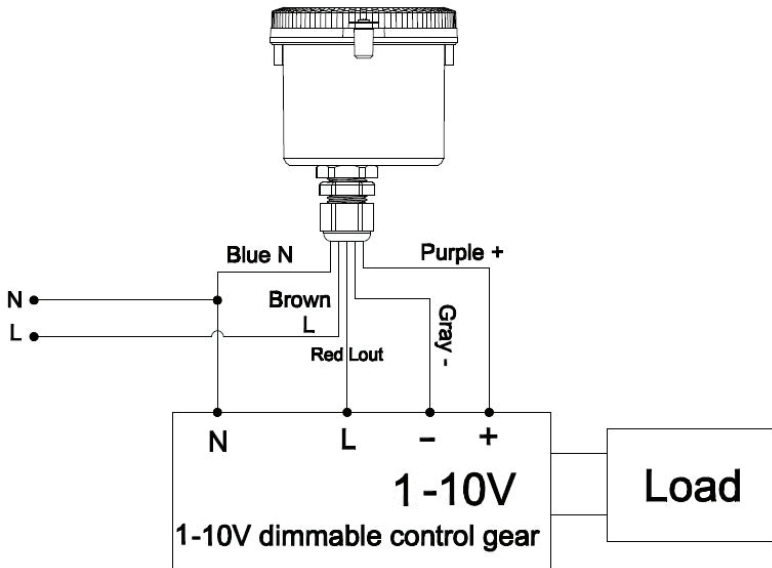

DIJGRAM ZA UGRADNJU

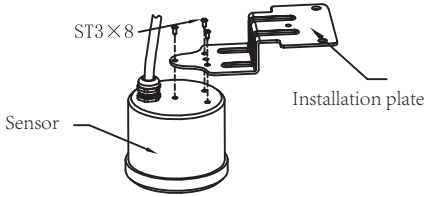
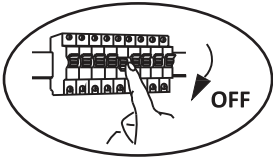

Connect wire box

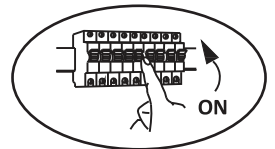
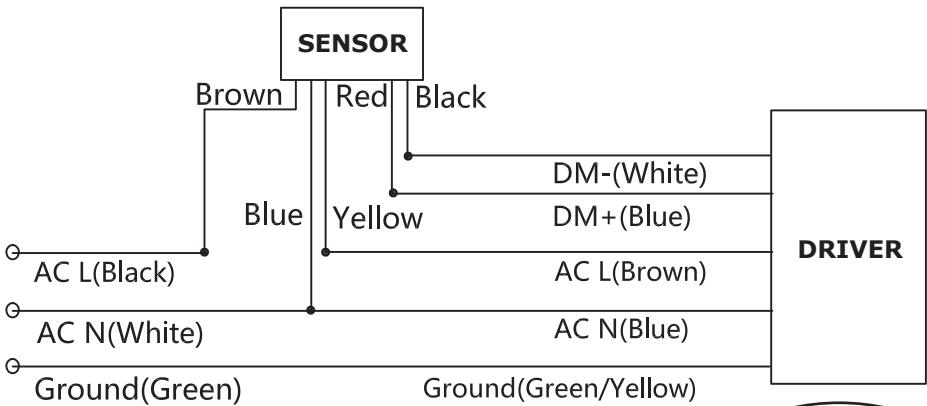
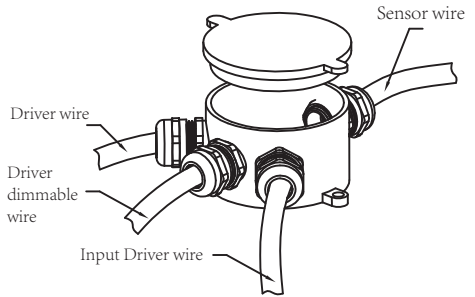
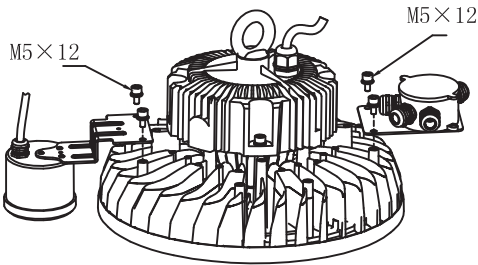
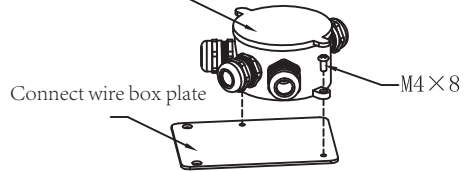

FUNKCIJSKI DIJAGRAM

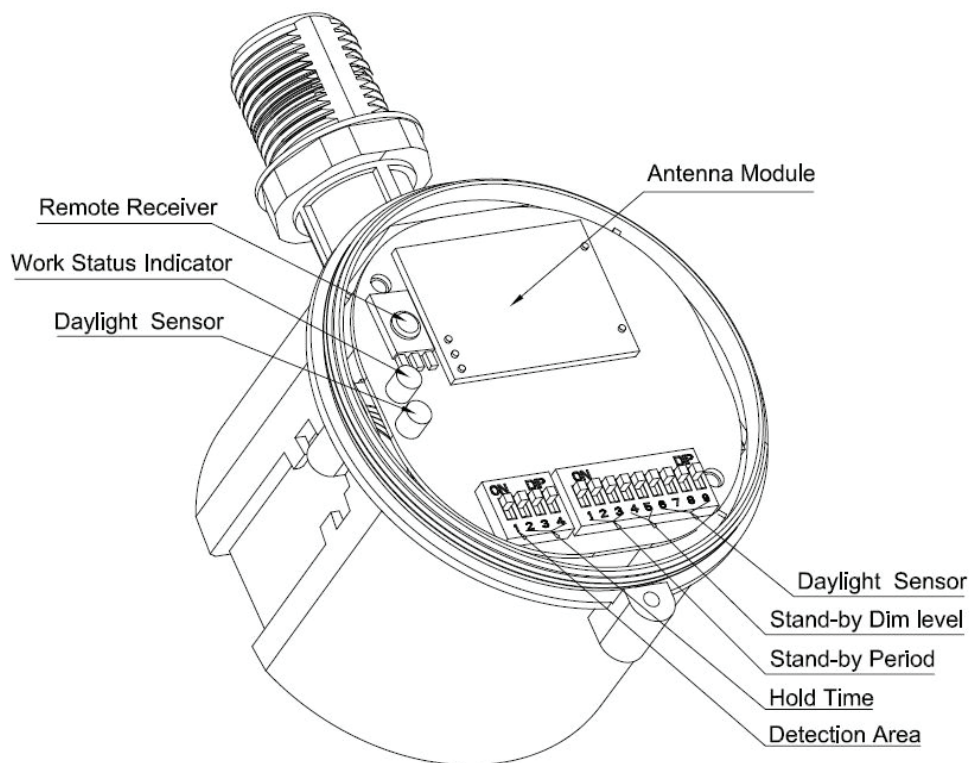

KONTROLA

(HOLD TIME)

	2	3	4	
I	ON	ON	ON	5s
II	-	ON	ON	30s
III	ON	-	ON	1min
IV	-	-	ON	3min
V	ON	ON	-	20min
VI	-	-	-	30min

(STAND-BY PERIOD)

	1	2	3	
I	ON	ON	ON	0s
II	-	ON	ON	1min
III	ON	-	ON	3min
IV	-	-	ON	10min
V	ON	ON	-	30min
VI	-	-	-	+∞

(STAND-BY DIM LEVEL)

	4	5	%	1-10V
I	ON	ON	10%	1.4-1.6V
II	ON	-	20%	1.9-2.1V
III	-	ON	30%	2.9-3.1V
IV		-	50%	4.9-5.1V

(DAYLIGHT SENSOR)

	6	7	8	9	
I	ON	ON	ON	ON	5Lux
II	-	ON	ON	ON	15Lux
III	ON	-	ON	ON	30Lux
IV	-	-	ON	ON	50Lux
V	ON	ON	-	ON	100Lux
VI	ON	ON	ON	-	150Lux
VII	-	-	-	-	Disable*

(DETECTION AREA)

	1	
I	ON	100%
II	-	50%

DIJAGRAM ZA UGRADNJU NA STROPU

Ceiling mounted
height: 3m
Sensitivity:
100%/75%/50%/25%

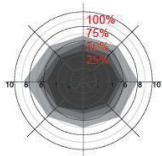

Normal moving
(Speed:1m/s)

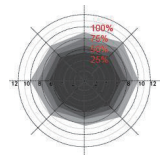

Slow moving
(Speed 0.3m/s)

Ceiling mounted
height: 6m
Sensitivity:
100%/75%/50%/25%

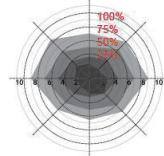

Normal moving
(Speed:1m/s)

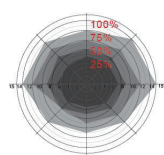

Slow moving
(Speed: 0.3m/s)

Ceiling mounted
height: 9m
Sensitivity:
100%/75%/50%/25%

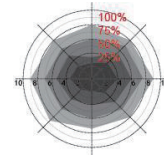

Normal moving
(Speed:1m/s)

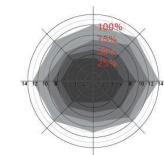

Slow moving
(Speed: 0.3m/s)

Ceiling mounted
height: 12m
Sensitivity:
100%/75%/50%

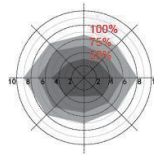

Normal moving
(Speed:1m/s)

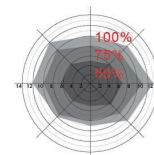

Slow moving
(Speed: 0.3m/s)

Ceiling mounted
height: 15m
Sensitivity:
100%/75%

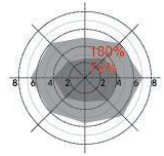

Normal moving
(Speed:1m/s)

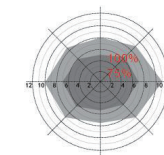

Slow moving
(Speed: 0.3m/s)

*Only 100%/75%/50% detection sensitivity is workable when installed at 10m & 15m mounting height. 25% sensitivity is not able to detect motion signal.

POČETAK

1. Funkcija uključivanja / isključivanja / 3-stupanjska funkcija zatamnjenja:

Nakon uključivanja, senzor automatski uključuje osvjetljenje pri 100% jačine svjetlosti.

Nakon 10 sekundi svjetlo se gasi. Tijekom inicijalizacije, senzor ne može registrirati pokret.

2. 2-stupanjska funkcija zatamnjenja:

Nakon uključivanja, senzor automatski uključuje osvjetljenje pri 100% jačine svjetlosti.

Nakon 10 sekundi, svjetlost se zatamnjuje na slabu razinu svjetla (postavljenu na razini zatamnjenja u stanju mirovanja). Tijekom inicijalizacije, senzor ne može registrirati pokret.

TVORNIČKE POSTAVKE

Zona registriranja pokreta: 100%, vrijeme mirovanja: 5S, vrijeme pripravnosti: 0s, razina zatamnjenja u pripravnosti: 10%, senzor ambijentalne svjetlosti: Isključivanje

OBAVIJEST O PRIMJENI

- 1) Ugradnju senzora mora obaviti samo stručni električar. Molimo, prije ugradnje i ožičenje, isključite struju. Promjenu postavki sklopke s dvorednim stezaljkama obavlja [DIP].
- 2) Senzor, koji je ugrađen u plastični i stakleni abažur smanjuje osjetljivost. Za svako povećanje debljine s 3 mm, osjetljivost se smanjuje za 20%.
- 3) Rezultati funkcije zatamnjenja mogu se razlikovati kod različitih pokretača 1-10v.
- 4) Prag svjetlosne osjetljivosti je u sunčanom okruženju, bez sjena i difuzne refleksije ambijentalne svjetlosti. Razina ambijentalne svjetlosti može biti različita u različitom okruženju, klimatskim uvjetima, doba dana i godišnjem dobu.
- 5) Može biti potrebno ponovno konfiguriranje parametara senzora u različitim tipovima instalacijskog okruženja.
- 6) Ovaj je senzor namijenjen samo za unutarnju uporabu. On će utjecati na vodootporno djelovanje u slučaju vanjske uporabe. Vjetar, kiša i pokretni predmeti oko senzora dovode do njegove nepotrebne aktivacije.
- 7) Udaljenost između bilo kojeg induktivnog senzora mora biti veća od 3 m.
- 8) Ne postavljajte senzor u blizini predmeta velike gustoće, poput metalnih, staklenih, betonskih zidova, jer je moguće nepotrebna aktivacija senzora. Kad se senzor ugradi u metalnu svjetiljku, metalne reflektirajuće površine ili tijesan zatvoreni prostor, mikrovalovi će se aktivirati višekratno i uzrokovati će nepotrebnu aktivaciju. Molimo, umanjite osjetljivost ili kontaktirajte proizvođača radi pružanja tehničke podrške.
- 9) Molimo, provjerite da oko senzora nema pokretnih signala, poput ventilatora, istosmjernog pogona, kanalizacijske cijevi, izlaza za zrak, itd., Senzor može uzrokovati nepotrebnu aktivaciju.
- 10) Savjetujemo vam da testirate 5 uzoraka prije masovne primjene senzora u novom projektu rasvjete.
- 11) Zbog kontinuiranog poboljšanja, sadržaj ovih uputa može se mijenjati bez prethodne najave.

INSTRUÇÕES DE INSTALAÇÃO HIGHBAY SENSOR



5 YEARS
WARRANTY*

INTRODUÇÃO E GARANTIA

Agradecemos que escolheu e adquiriu o produto da V-TAC. A V-TAC irá servir-lhe da melhor maneira possível. Por favor, leia atentamente estas instruções antes da instalação e mantenha este manual para referência no futuro. Se tiver outras dúvidas, entre em contacto com o nosso revendedor ou comerciante local de quem adquiriu o produto. Eles são formados e estão prontos para lhe serem úteis da melhor maneira possível. A garantia é válida por um período de 5 anos a partir da data de compra. A garantia não se aplica a danos causados devido a uma instalação incorrecta ou desgaste invulgar. A empresa não dá nenhuma garantia por danos de qualquer superfície devido à inadequada remoção e instalação do produto.

ATENÇÃO

1. Por favor, desligue a energia e leia esta instrução antes de iniciar a instalação.
2. A instalação só pode ser feita por electricista autorizado.



Este símbolo indica que este produto não deve ser descartado juntamente com o lixo doméstico



Cuidado, risco de choque elétrico.

CARATERÍSTICAS DO PRODUTO

1. Tensão de operação 100/277 V CA, 50/60 Hz
2. A altura máxima de montagem da antena de microondas é 15 m, adequada para instalação na maioria dos armazéns.
3. Suporta modos de alta e de baixa sensibilidade (para tetos de metal, áreas de instalação de refletores de metal) e operação com LED dimmer de 1-10V, função de escurecimento de 2 ou 3 níveis.
4. Compatível com os modelos Highbay de V-TAC, VT-9-151 e VT-9-200

PARÂMETROS

Input	Operating Voltage Range	108-305V AC, 50Hz/60Hz
	DC Input Voltage	N/A
	Rated Voltage	100/277V AC, 50Hz/60Hz
	No-load Power	N/A
	Stand-by Power	<1W
Output	Surge Test	L-N: 1kV
	Working Mode	ON/OFF function, 1-10V step dimming
	Type of Load	Inductive or resistive Load
	Load Capacity	100VAC: 4A; 277VAC: 3A
	Current of Load	N/A
Dim Interface	Max. Surge Capacity	50A (50% Ipeak, twidth =500uS, 230Vac full load, cold start);
		80A (50% Ipeak, twidth =200uS, 230Vac, full load, cold start)
	1-10V Dimming	< 50mA (Non-constant source) 10%(1.4-1.6V), 20%(1.9-2.1V), 30%(2.9-3.1V), 50% (4.9-5.1V)
	Synchronous Control	N/A
Sensor Parameters	High Low-level	N/A
	PWM Control	N/A
	Operating Frequency	5.8 GHz ±75 MHz, ISM Band.
	Transmitting power	0.5mW Max.
	Hold time	5s/30s/1min/3min/5min/10min/20min/30min
Others	Stand-by DIM Level	10%/20%/30%/50%
	Stand-by Period	0s/10s/1min/3min/5min/10min/30min/+∞
	Detection Area	25%/50%/75%/100%
	Daylight Sensor	5lux/15lux/30lux/50lux/100lux/150lux/Disable (Ambient light diffusion)
	Mounting Height	15m Max
	Detecting Angle	360°(ceiling mounting)
	Operating Environment	Operating Temperature
Storage Temperature		Temperature:-40 to +80; Humidity:10%-95% (non-condensing)
Others	Wiring	H05RR-F,5*18AWG exposed line length: 810-830mm
	Wiring Color	Sheath: blue, brown, red, purple, gray
	IP Rating	IP65
	Protection Class	Class II
	Installation	Independent
	Dimension	(ΦxH)72*59mm
Lifetime	50,000h @ Ta Full load	

Nota

1. "N/A" significa não disponível.
2. A zona de detecção depende do volume do objeto em movimento e da velocidade do movimento. A zona de detecção é provada por uma pessoa com altura de 165 cm e velocidade de 0,5 m/s.

FUNÇÕES

1. Função de LIGAR/DESLIGAR (período de espera definido para "0")

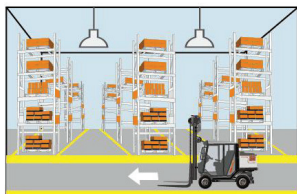

1. Com luz de ambiente suficiente, a luz não se LIGARA, mesmo se um sinal de movimento estiver disponível.

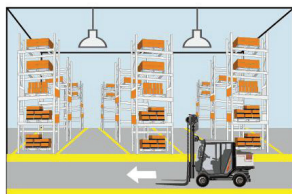

2. Com luz de ambiente suficiente, o sensor liga a luz ao detetar movimento.

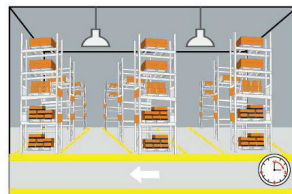

3. Depois de decorrido o tempo de espera, o sensor desliga a luz quando nenhum movimento é detectado.

2) Função de escurecimento de 2 níveis (período de espera definido para "+∞")

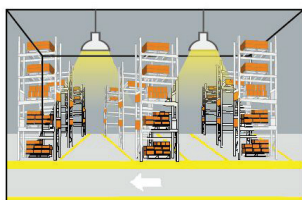

1. Se nenhum movimento for detectado, a luz permanece acesa num nível baixo de iluminação durante o tempo todo.

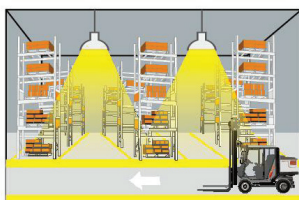

2. Ao detetar movimento, o sensor liga a luz com 100% de brilho.

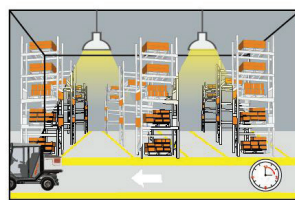

3. Depois de decorrido o tempo de espera, o sensor irá diminuir a luz para o atual baixo nível de luz, caso nenhum movimento seja detetado.

3) Função de escurecimento de 3 níveis (período de espera definido para "10 segundos/1 minuto / 3 minutos /5 minutos /10 minutos /30 minutos")

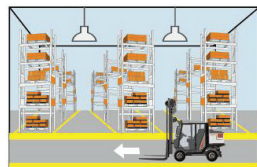

1. Com luz de ambiente suficiente, a luz não será ligada, mesmo se houver sinal de movimento.

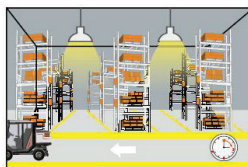

2. Com luz de ambiente suficiente, o sensor liga a luz de deteção de movimento.

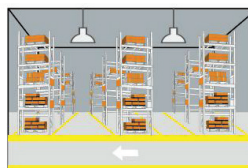

3. Após o tempo de retenção ter decorrido, o sensor irá diminuir a luz para um baixo nível de luz se nenhum novo movimento for detectado.

4. Depois de decorrido o período de espera, o sensor apaga a luz se nenhum movimento for detectado na área de deteção.

DIAGRAMA DE DIMENÇÕES



DIAGRAMA DE FIAÇÃO



DIAGRAMA DE INSTALAÇÃO

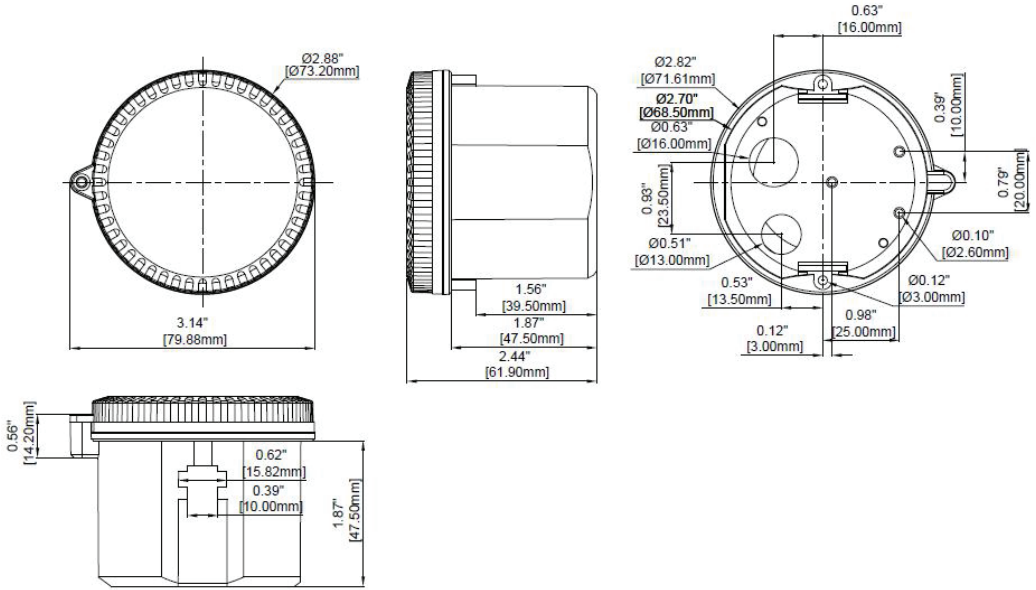

DIAGRAMA DE FUNÇÃO

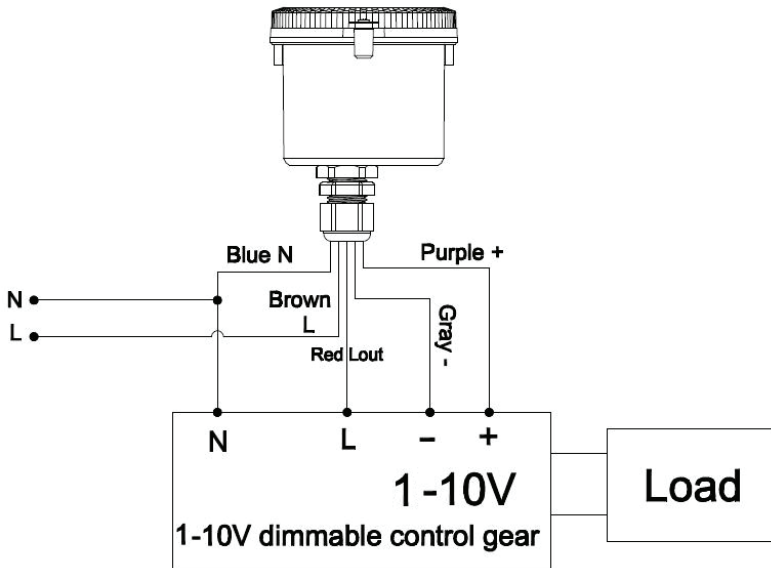

CONTROLOS

(HOLD TIME)

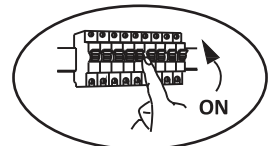
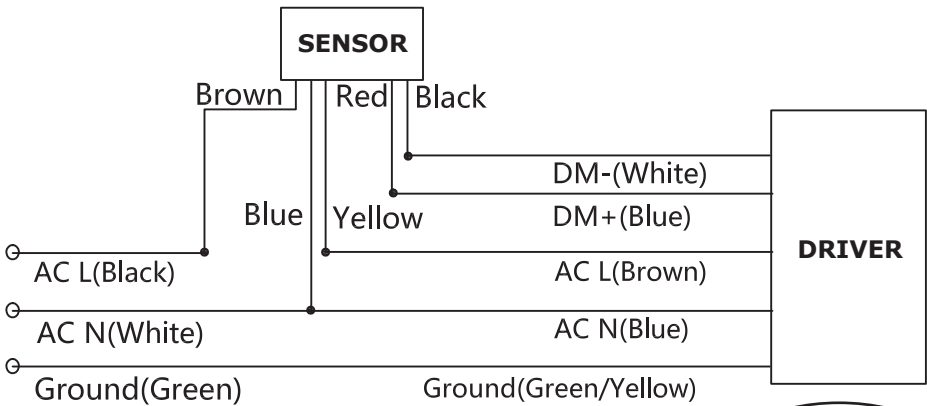
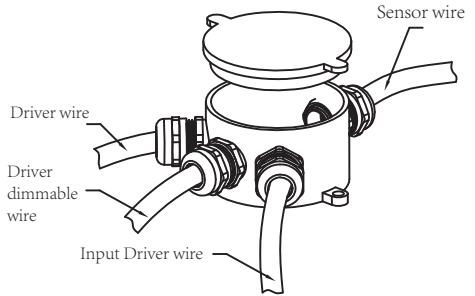
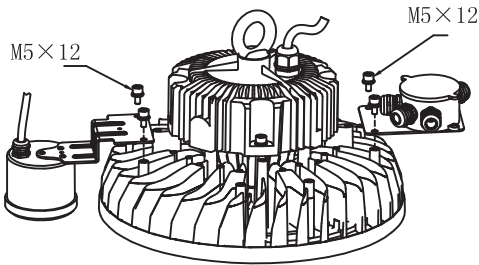
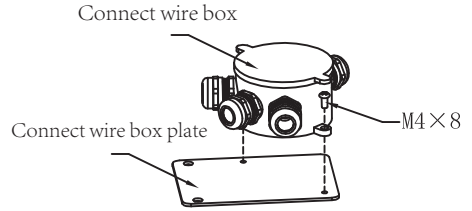
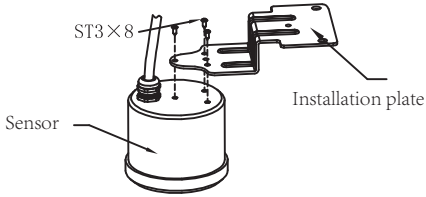
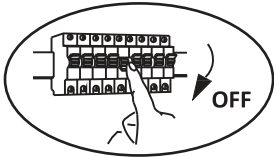
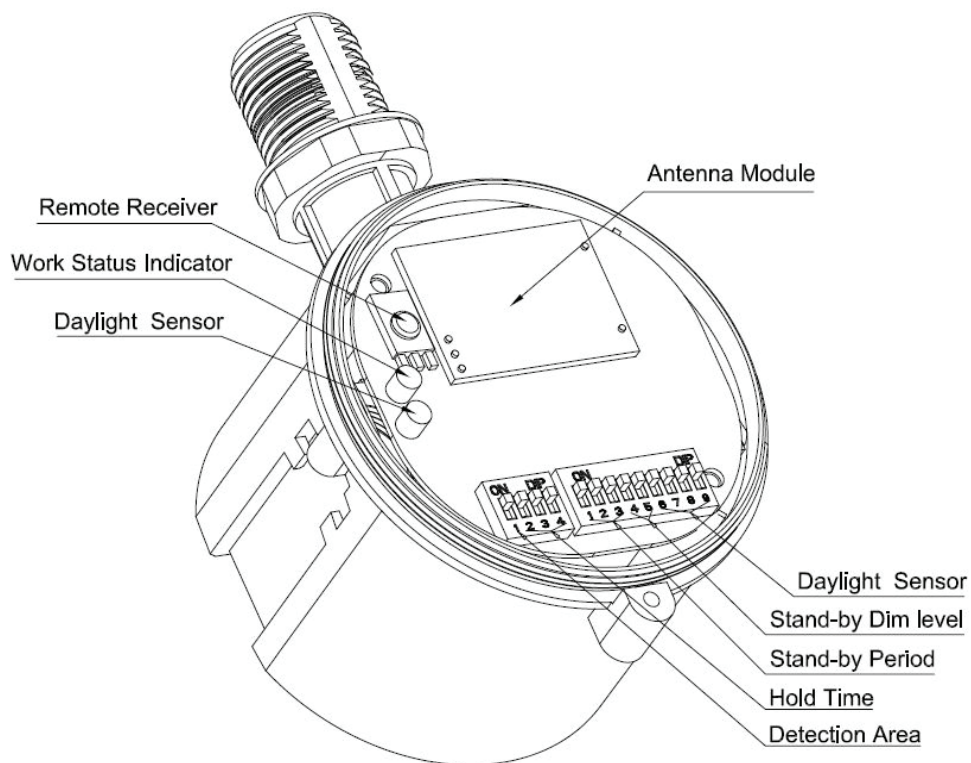
	2	3	4	
I	ON	ON	ON	5s
II	-	ON	ON	30s
III	ON	-	ON	1min
IV	-	-	ON	3min
V	ON	ON	-	20min
VI	-	-	-	30min

(STAND-BY PERIOD)

	1	2	3	
I	ON	ON	ON	0s
II	-	ON	ON	1min
III	ON	-	ON	3min
IV	-	-	ON	10min
V	ON	ON	-	30min
VI	-	-	-	+∞

(STAND-BY DIM LEVEL)

	4	5	%	1-10V
I	ON	ON	10%	1.4-1.6V
II	ON	-	20%	1.9-2.1V
III	-	ON	30%	2.9-3.1V
IV		-	50%	4.9-5.1V

(DAYLIGHT SENSOR)

	6	7	8	9	
I	ON	ON	ON	ON	5Lux
II	-	ON	ON	ON	15Lux
III	ON	-	ON	ON	30Lux
IV	-	-	ON	ON	50Lux
V	ON	ON	-	ON	100Lux
VI	ON	ON	ON	-	150Lux
VII	-	-	-	-	Disable*

(DETECTION AREA)

	1	
I	ON	100%
II	-	50%

DIAGRAMA DE INSTALAÇÃO NO TETO

Ceiling mounted
height: 3m
Sensitivity:
100%/75%/50%/25%

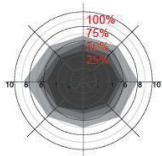

Normal moving
(Speed:1m/s)

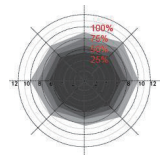

Slow moving
(Speed 0.3m/s)

Ceiling mounted
height: 6m
Sensitivity:
100%/75%/50%/25%

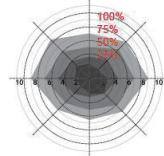

Normal moving
(Speed:1m/s)

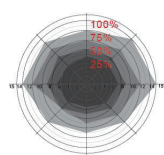

Slow moving
(Speed: 0.3m/s)

Ceiling mounted
height: 9m
Sensitivity:
100%/75%/50%/25%

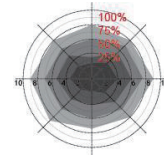

Normal moving
(Speed:1m/s)

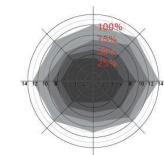

Slow moving
(Speed: 0.3m/s)

Ceiling mounted
height: 12m
Sensitivity:
100%/75%/50%

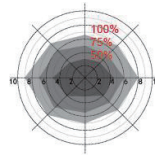

Normal moving
(Speed:1m/s)

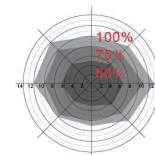

Slow moving
(Speed: 0.3m/s)

Ceiling mounted
height: 15m
Sensitivity:
100%/75%

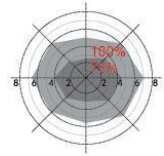

Normal moving
(Speed:1m/s)

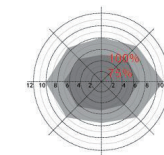

Slow moving
(Speed: 0.3m/s)

*Only 100%/75%/50% detection sensitivity is workable when installed at 10m & 15m mounting height. 25% sensitivity is not able to detect motion signal.

INICIALIZAÇÃO

1. Função de ligar/desligar/função de escurecimento de 3 níveis:

Depois de estar ligado, o sensor liga automaticamente a iluminação com 100% de brilho. Após 10 segundos, ele apaga a luz. Durante a inicialização, o sensor não consegue detectar movimento.

2. Função de escurecimento de 2 níveis:

Depois de ligado, o sensor liga automaticamente a iluminação com 100% de brilho. Após 10 segundos, ele escurece a luz para um baixo nível de luz (definido pelo nível de escurecimento no modo de espera). Durante a inicialização, o sensor não consegue detectar movimento.

CONFIGURAÇÕES DE FÁBRICA

Zona de detecção: 100%, tempo de retenção: 5S, período de espera: 0s, nível de escurecimento de espera: 10%, sensor de luz do dia: Parar

NOTIFICAÇÃO DE APLICAÇÃO

- 1) O sensor deve ser instalado por um electricista profissional. Desligue a alimentação antes da instalação, fiação, alteração da configuração da chave DIP.
- 2) O sensor, que é instalado no abajur de plástico e vidro, reduz a sensibilidade. Para cada aumento de espessura de 3 mm, a sensibilidade é reduzida em 20%.
- 3) Os resultados da função de escurecimento podem diferir para diferentes controladores 1-10v.
- 4) O limite de sensibilidade à luz é num ambiente ensolarado, sem sombras e sem reflexão difusa da luz de ambiente. O nível de iluminação de ambiente pode ser diferente em diferentes ambientes, condições atmosféricas, clima, hora do dia e estação do ano.
- 5) Pode ser necessário reconfigurar os parâmetros do sensor em diferentes tipos de ambiente de instalação.
- 6) Este sensor é apenas para uso interno. Isso afetará a ação à prova de água para uso ao ar livre. Vento, chuva e objetos em movimento levam a uma ativação desnecessária.
- 7) A distância entre quaisquer sensores indutivos deve ser maior que 3 m.
- 8) Não coloque o sensor perto de objetos de alta densidade, como metal, vidro, paredes de betão, pois pode ser provocada uma ativação desnecessária. Quando o sensor é instalado numa lâmpada de metal, superfícies reflexivas de metal ou num espaço fechado e estreito, as microondas serão refletidas repetidamente e levarão à ativação desnecessária. Reduza a sensibilidade ou entre em contato com o fabricante para obter suporte técnico.
- 9) Certifique-se de que não haja sinais de movimento ao redor do sensor, como ventilador, unidade de CC, cano de esgoto, saída de ar, etc., o sensor pode provocar ativação desnecessária.
- 10) Aconselhamos que teste 5 amostras antes da aplicação em massa do sensor num novo projeto de iluminação.
- 11) Devido à melhoria contínua, o conteúdo destas instruções está sujeito a alterações sem aviso prévio.

ΟΔΗΓΙΕΣ ΓΙΑ ΤΗΝ ΤΟΠΟΘΕΤΗΣΗ HIGHBAY SENSOR



5 YEARS
WARRANTY*

ΕΙΣΑΓΩΓΗ - ΕΓΓΥΗΣΗ

Σας ευχαριστούμε για το ότι επιλέξατε και αγοράσατε το προϊόν της Βi-TAK(V-TAC). Η Βi-TAK (V-TAC) θα σας εξυπηρετήσει με τον καλύτερο δυνατό τρόπο. Παρακαλούμε να διαβάσετε προσεκτικά τις οδηγίες μας προτού τοποθετήσετε και διατηρήσετε τις οδηγίες για τη μετέπειτα ενημέρωσή σας. Αν έχετε άλλα ερωτήματα και απορίες, παρακαλούμε να έλθετε σε επαφή με τον προμηθευτή μας ή με τον εγχώριο έμπορο από τον οποίο αγοράσατε το προϊόν. Αυτοί εκπαιδεύτηκαν κατάλληλα και είναι πρόθυμοι να σας εξυπηρετήσουν με τον καλύτερο τρόπο. Η εγγύηση ισχύει για περίοδο 5 ετών από την ημερομηνία της αγοράς. Η εγγύηση δεν εφαρμόζεται σε περίπτωση που προκληθούν ζημιές εξαιτίας λάθους τοποθέτησης ή ασυνήθιστης φθοράς. Η εταιρεία δεν παρέχει εγγύηση για ζημιές σε οποιαδήποτε επιφάνεια εξαιτίας τις λάθος απομάκρυνσης ή τοποθέτησης του προϊόντος.

ΠΡΟΣΟΧΗ

- Διαβάστε αυτές τις οδηγίες και απενεργοποιήστε την τροφοδοσία πριν να αρχίσετε με την εγκατάσταση.
- Τοποθέτηση μόνο από αδειούχο ηλεκτρολόγο



Αυτή η σήμανση υποδεικνύει ότι αυτό το προϊόν δεν πρέπει να απορρίπτεται με άλλα οικιακά απορρίμματα.



Προσοχή, κίνδυνος ηλεκτροπληξίας.

ΧΑΡΑΚΤΗΡΙΣΤΙΚΑ ΠΡΟΪΟΝΤΟΣ

1. Τάση λειτουργίας 100 / 277V AC, 50 / 60Hz
2. Το ύψος τοποθέτησης της κεραίας μικροκυμάτων είναι το πιο πολύ 15 m, κατάλληλο για εγκατάσταση στις περισσότερες αποθήκες.
3. Υποστηρίζει λειτουργίες υψηλής ευαισθησίας και χαμηλής ευαισθησίας (για μεταλλικές οροφές, ζώνες τοποθέτησης μεταλλικών ανακλαστήρων) και λειτουργία με πρόγραμμα LED οδήγησης για εξασθένιση 1-10V, εύκολη πρόσβαση σε λειτουργία εξασθένισης 2-σταδίων ή 3-σταδίων.
4. Συμβατό με μοντέλα Wi-Tech VT-9-151 και VT-9-200 της Highbay

ΠΑΡΑΜΕΤΡΟΙ

Input	Operating Voltage Range	108-305V AC, 50Hz/60Hz
	DC Input Voltage	N/A
	Rated Voltage	100/277V AC, 50Hz/60Hz
	No-load Power	N/A
	Stand-by Power	<1W
Output	Surge Test	L-N: 1kV
	Working Mode	ON/OFF function, 1-10V step dimming
	Type of Load	Inductive or resistive Load
	Load Capacity	100VAC: 4A; 277VAC: 3A
	Current of Load	N/A
Dim Interface	Max. Surge Capacity	50A (50% Ipeak, twidth =500uS, 230Vac full load, cold start);
		80A (50% Ipeak, twidth =200uS, 230Vac, full load, cold start)
	1-10V Dimming	< 50mA (Non-constant source) 10%(1.4-1.6V), 20%(1.9-2.1V), 30%(2.9-3.1V), 50% (4.9-5.1V)
	Synchronous Control	N/A
Sensor Parameters	High Low-level	N/A
	PWM Control	N/A
	Operating Frequency	5.8 GHz ±75 MHz, ISM Band.
	Transmitting power	0.5mW Max.
	Hold time	5s/30s/1min/3min/5min/10min/20min/30min
Others	Stand-by DIM Level	10%/20%/30%/50%
	Stand-by Period	0s/10s/1min/3min/5min/10min/30min/+∞
	Detection Area	25%/50%/75%/100%
	Daylight Sensor	5lux/15lux/30lux/50lux/100lux/150lux/Disable (Ambient light diffusion)
	Mounting Height	15m Max
Operating Environment	Detecting Angle	360°(ceiling mounting)
	Operating Temperature	-35 to +55
Others	Storage Temperature	Temperature:-40 to +80; Humidity:10%-95% (non-condensing)
	Wiring	H05RR-F,5*18AWG exposed line length: 810-830mm
	Wiring Color	Sheath: blue, brown, red, purple, gray
	IP Rating	IP65
	Protection Class	Class II
	Installation	Independent
	Dimension	(ΦxH)72*59mm
Lifetime	50,000h @ Ta Full load	

Σημείωση

1. "N/A" σημαίνει ότι δεν είναι διαθέσιμο.
2. Η ζώνη ανίχνευσης εξαρτάται από τον όγκο του κινούμενου αντικειμένου και την ταχύτητα κίνησης. Η ζώνη ανίχνευσης ελέγχεται από άτομο με ύψος 165 cm και ταχύτητα 0,5 m / s.

ΛΕΙΤΟΥΡΓΙΕΣ

1. Λειτουργία ΕΝΕΡΓΟΠΟΙΗΣΗΣ/ΑΠΕΝΕΡΓΟΠΟΙΗΣΗΣ (για περίοδο αναμονής ορίζεται "0")

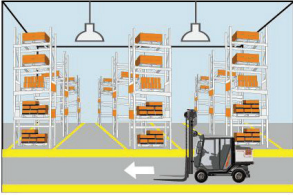

1. Λειτουργία ΕΝΕΡΓΟΠΟΙΗΣΗΣ/ΑΠΕΝΕΡΓΟΠΟΙΗΣΗΣ (για περίοδο αναμονής ορίζεται "0")

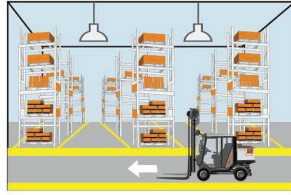

2. Με επαρκές φως του περιβάλλοντος, ο αισθητήρας ανάβει τη λυχνία σε περίπτωση ανίχνευσης κίνησης.

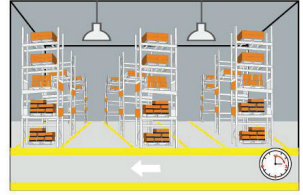

3. Αφού παρέλθει ο χρόνος αναμονής, ο αισθητήρας σβήνει το φως όταν δεν ανιχνεύεται κίνηση.

- 2) Λειτουργία εξασθένισης 2-σταδίων (η περίοδος αναμονής ορίζεται για "+∞")

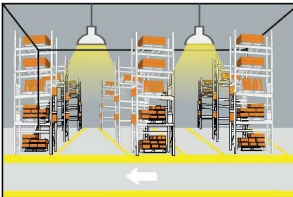

1. Εάν δεν ανιχνευθεί καμία κίνηση, το φως παραμένει αναμμένο σε χαμηλό επίπεδο φωτισμού μόνιμα.

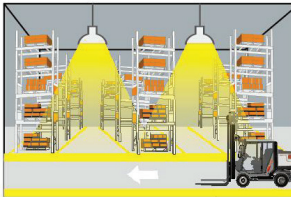

2. Όταν ανιχνεύεται κίνηση, ο αισθητήρας ανάβει το φως με φωτεινότητα 100%.

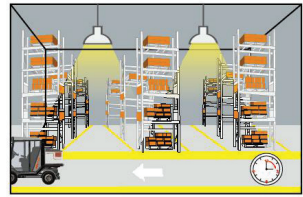

3. Αφού παρέλθει ο χρόνος αναμονής, ο αισθητήρας θα μειώσει το φως στο τρέχον επίπεδο χαμηλού φωτισμού σε περίπτωση που δεν ανιχνευθεί κίνηση.

- 3) Λειτουργία εξασθένισης 3-σταδίων (η περίοδος αναμονής ορίζεται για "10 δευτερόλεπτα / 1 λεπτό / 3 λεπτά / 5 λεπτά / 10 λεπτά / 30 λεπτά")

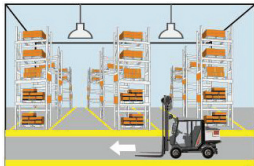

1. Με επαρκές φως του περιβάλλοντος, το φως δεν θα ανάβει ακόμα και αν υπάρχει σήμα κίνησης.

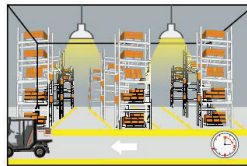

3. Αφού παρέλθει ο χρόνος αναμονής, ο αισθητήρας θα μειώσει το φως στο χαμηλό επίπεδο φωτός εάν δεν ανιχνευθεί νέα κίνηση.

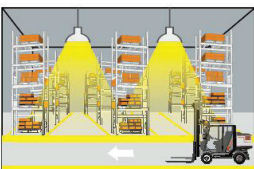

2. Με επαρκές φως του περιβάλλοντος, ο αισθητήρας ανάβει τη λυχνία ανίχνευσης κίνησης.

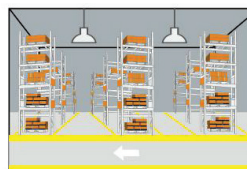

4. Αφού παρέλθει ο χρόνος αναμονής, ο αισθητήρας σβήνει το φως εάν δεν ανιχνευθεί κίνηση στην περιοχή ανίχνευσης.

ΔΙΑΓΡΑΜΜΑ ΔΙΑΣΤΑΣΕΩΝ

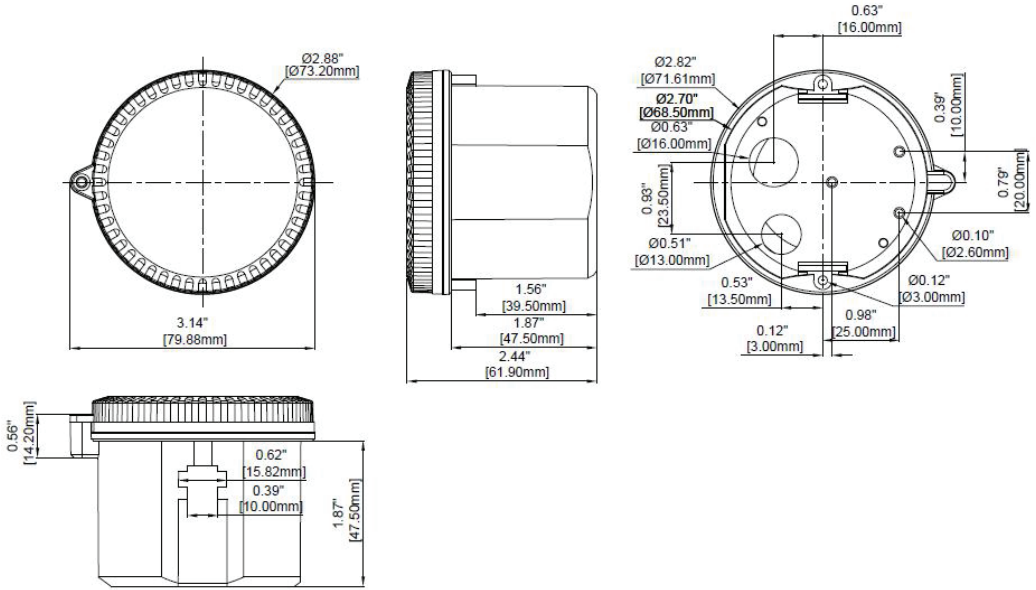

ΔΙΑΓΡΑΜΜΑ ΚΑΛΩΔΙΩΣΗΣ

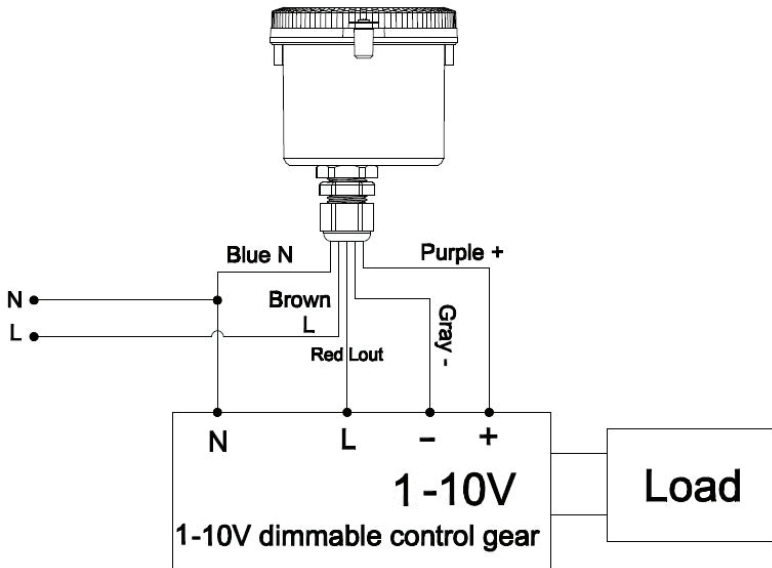

ΔΙΑΓΡΑΜΜΑ ΕΓΚΑΤΑΣΤΑΣΗΣ

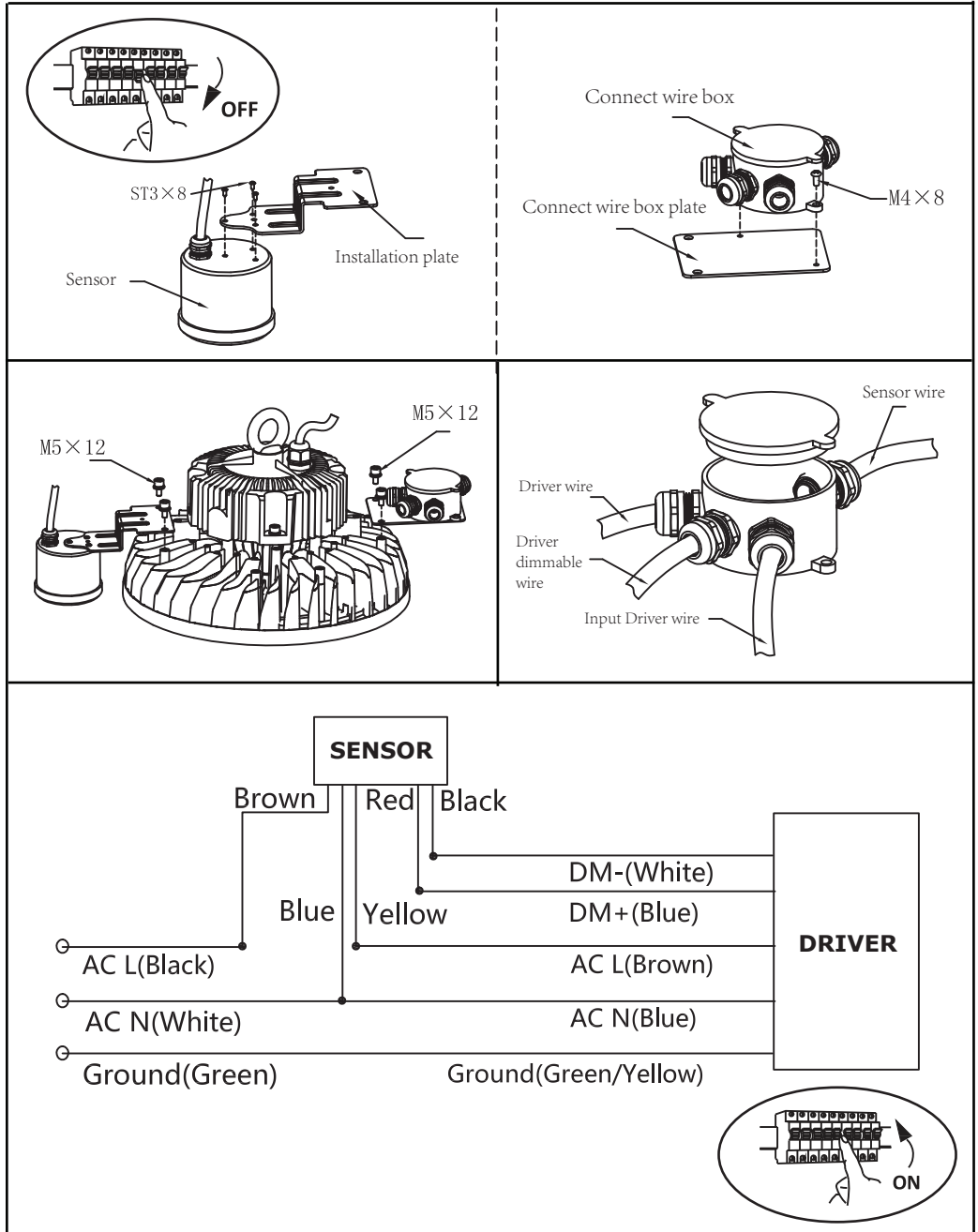

ΔΙΑΓΡΑΜΜΑ ΛΕΙΤΟΥΡΓΙΑΣ

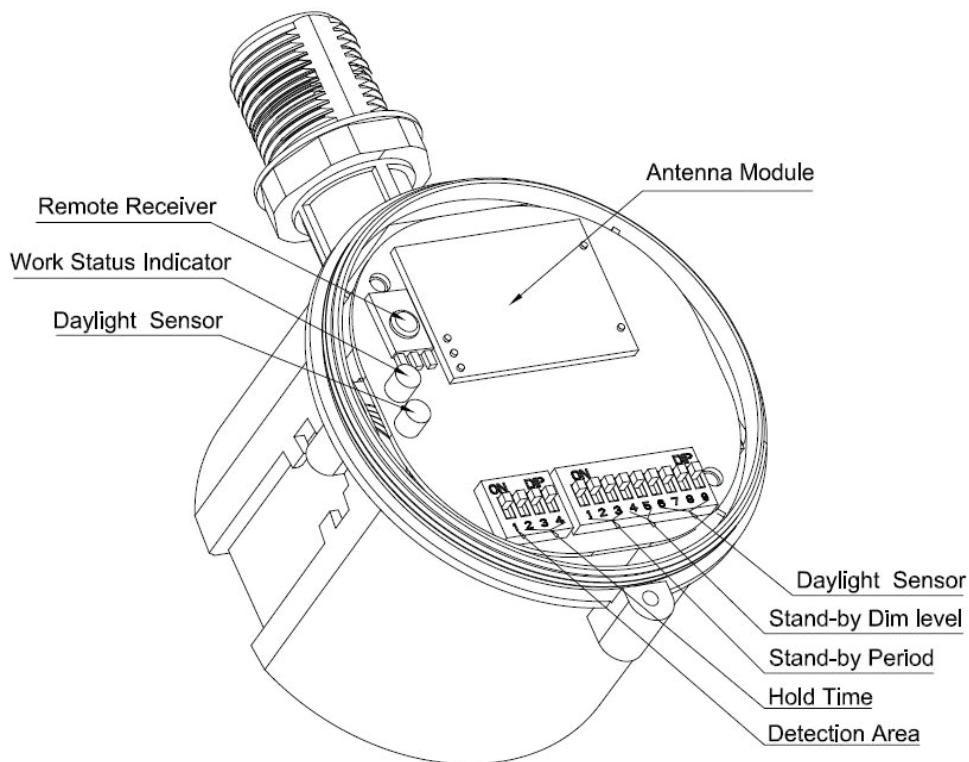

ΕΛΕΓΧΟΣ

(HOLD TIME)

	2	3	4	
I	ON	ON	ON	5s
II	-	ON	ON	30s
III	ON	-	ON	1min
IV	-	-	ON	3min
V	ON	ON	-	20min
VI	-	-	-	30min

(STAND-BY PERIOD)

	1	2	3	
I	ON	ON	ON	0s
II	-	ON	ON	1min
III	ON	-	ON	3min
IV	-	-	ON	10min
V	ON	ON	-	30min
VI	-	-	-	+∞

(STAND-BY DIM LEVEL)

	4	5	%	1-10V
I	ON	ON	10%	1.4-1.6V
II	ON	-	20%	1.9-2.1V
III	-	ON	30%	2.9-3.1V
IV		-	50%	4.9-5.1V

(DAYLIGHT SENSOR)

	6	7	8	9	
I	ON	ON	ON	ON	5Lux
II	-	ON	ON	ON	15Lux
III	ON	-	ON	ON	30Lux
IV	-	-	ON	ON	50Lux
V	ON	ON	-	ON	100Lux
VI	ON	ON	ON	-	150Lux
VII	-	-	-	-	Disable*

(DETECTION AREA)

	1	
I	ON	100%
II	-	50%

ΔΙΑΓΡΑΜΜΑ ΕΓΚΑΤΑΣΤΑΣΗΣ ΣΤΗΝ ΟΡΟΦΗ

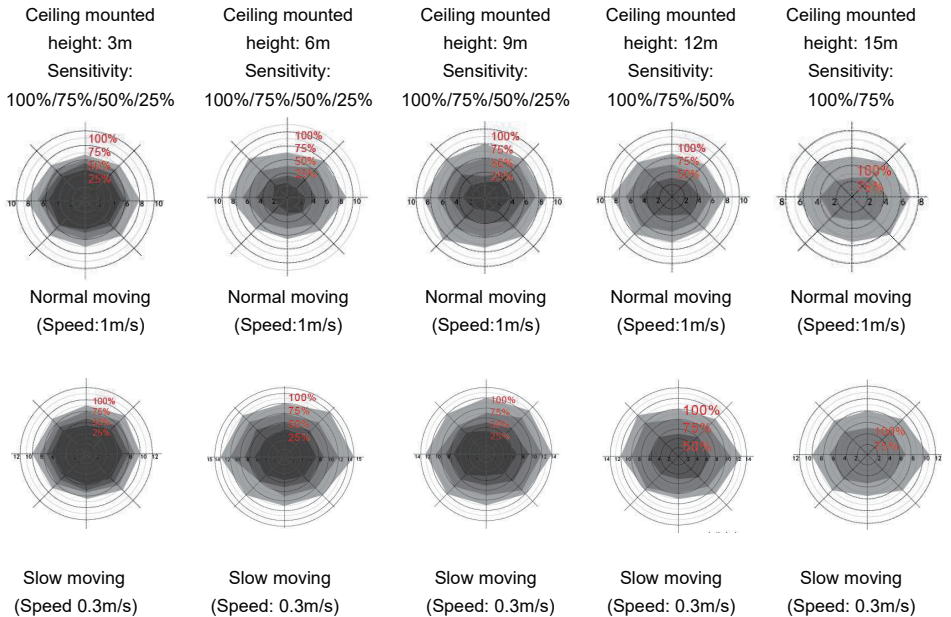

*Only 100%/75%/50% detection sensitivity is workable when installed at 10m & 15m mounting height. 25% sensitivity is not able to detect motion signal.

ΕΚΚΙΝΗΣΗ

1. Λειτουργία ενεργοποίησης/απενεργοποίησης/λειτουργία εξασθένισης 3-σταδίων:

Μετά την ενεργοποίηση, ο αισθητήρας ανάβει αυτόματα τον φωτισμό με φωτεινότητα 100%. Μετά από 10 δευτερόλεπτα, μειώνει το φως. Κατά την αρχικοποίηση, ο αισθητήρας δεν μπορεί να ανιχνεύει κίνηση.

2. Λειτουργία εξασθένισης 2-σταδίων:

Μετά την ενεργοποίηση, ο αισθητήρας ανάβει αυτόματα τον φωτισμό με φωτεινότητα 100%. Μετά από 10 δευτερόλεπτα, μειώνει το φως σε χαμηλό επίπεδο φωτισμού (ρυθμίζεται από το επίπεδο εξασθένισης σε κατάσταση αναμονής). Κατά την αρχικοποίηση, ο αισθητήρας δεν μπορεί να ανιχνεύει κίνηση

ΕΡΓΟΣΤΑΣΙΑΚΗ ΡΥΘΜΙΣΗ

Ζώνη ανίχνευσης: 100%, χρόνος κατακράτησης: 5S, χρόνος αναμονής: 0s, επίπεδο εξασθένισης σε αναμονή: 10%, αισθητήρας φωτός ημέρας: Διακοπή

ΕΙΔΟΠΟΙΗΣΗ ΕΦΑΡΜΟΓΗΣ

- 1) Ο αισθητήρας πρέπει να εγκατασταθεί από εξειδικευμένο ηλεκτρολόγο. Απενεργοποιήστε την τροφοδοσία πριν από εγκατάσταση, καλωδίωση, αλλαγή ρύθμισης διακόπτη με τερματικά δύο σειρών [DIP].
- 2) Ο αισθητήρας, ο οποίος είναι τοποθετημένος στο πλαστικό και το γυάλινο αμπαζούρ, μειώνει την ευαισθησία.
Για κάθε αύξηση πάχους 3 mm, η ευαισθησία μειώνεται κατά 20%.
- 3) Τα αποτελέσματα της λειτουργίας εξασθένισης μπορούν να διαφέρουν για τα διαφορετικά προγράμματα οδήγησης 1-10n.
- 4) Το όριο ευαισθησίας φωτός βρίσκεται σε ηλιόλουστο περιβάλλον, χωρίς σκιές και διάχυτη ανάκλαση του φωτός περιβάλλοντος. Το επίπεδο του φωτισμού περιβάλλοντος μπορεί να είναι διαφορετικό ανάλογα με το διαφορετικό περιβάλλον, καιρό, κλίμα, ώρα της ημέρας και εποχή.
- 5) Ίσως χρειαστεί να επαναδιαμορφώσετε τις παραμέτρους του αισθητήρα σε διαφορετικούς τύπους περιβάλλοντος εγκατάστασης.
- 6) Αυτός ο αισθητήρας προορίζεται μόνο για εσωτερική χρήση. Αυτός θα επηρεάσει την αδιάβροχη δράση για εξωτερική χρήση. Ο άνεμος, η βροχή και τα κινούμενα αντικείμενα οδηγούν σε περιπτή ενεργοποίηση.
- 7) Η απόσταση μεταξύ τυχόν επαγωγικών αισθητήρων πρέπει να είναι μεγαλύτερη από 3 m.
- 8) Μην τοποθετείτε τον αισθητήρα κοντά σε αντικείμενα υψηλής πυκνότητας, όπως μεταλλικά και γυάλινα τοίχοι και τοίχοι από μπετόν, επειδή είναι δυνατή η περιπτή λειτουργία. Όταν ο αισθητήρας είναι εγκατεστημένος σε μεταλλική λυχνία, μεταλλικές ανακλαστικές επιφάνειες ή σφιχτό κλειστό χώρο, τα μικροκύματα θα ανακλώνται επανειλημμένα και θα προκαλέσουν περιπτή ενεργοποίηση. Μειώστε την ευαισθησία ή επικοινωνήστε με τον κατασκευαστή για τεχνική υποστήριξη.
- 9) Βεβαιωθείτε ότι δεν υπάρχουν κινούμενα σήματα γύρω από τον αισθητήρα, όπως ανεμιστήρας, ενεργοποίησης συνεχούς ρεύματος, σωλήνας αποχέτευσης, έξοδος αέρα κ.λπ., ο αισθητήρας μπορεί να προκαλέσει περιπτή ενεργοποίηση.
- 10) Σας συμβουλεύουμε να δοκιμάσετε 5 δείγματα πριν από τη μαζική εφαρμογή του αισθητήρα σε ένα νέο έργο φωτισμού.
- 11) Λόγω συνεχούς βελτίωσης, το περιεχόμενο αυτών των οδηγιών υπόκειται σε αλλαγές χωρίς προειδοποίηση.

INSTRUKCJE INSTALACJI HIGHBAY SENSOR



5 YEARS
WARRANTY*

WSTĘP I GWARANCJAD

Dziękujemy za wybór i zakup produktu V-TAC. V-TAC będzie Ci służył najlepiej. Proszę przeczytać tę instrukcję uważnie przed przystąpieniem do zainstalowania i zachować ją do użytku w przyszłości. Jeśli masz jakieś pytania, proszę kontaktować się z naszym Przedstawicielem lub z dystrybutorem, od którego kupiłeś produkt. Oni są przeszkoleni i gotowi udzielić Ci pomocy. Gwarancja ważna jest 5 lat od zakupu. Gwarancja nie obejmuje uszkodzeń wynikających z niewłaściwego zainstalowania lub nadzwyczajnego zużycia. Spółka nie ponosi odpowiedzialności za ewentualne szkody spowodowane na powierzchniach podczas instalacji lub deinstalacji.

UWAGA

1. Przed rozpoczęciem montażu przeczytaj te instrukcje i odłącz zasilanie.
2. Instalacja powinna być wykonywana wyłącznie przez elektrotechnika posiadającego certyfikat.dado!



Oznakowanie to wskazuje, że tego produktu nie należy wyrzucać razem z innymi odpadami domowymi.



Uwaga, ryzyko porażenia prądem.

CHARAKTERYSTYKA PRODUKTU

1. Napięcie robocze 100/277V AC, 50/60Hz
2. Wysokość montażu anteny mikrofalowej wynosi maksymalnie 15 m, tzn. antena jest odpowiednia do montażu w większości magazynów.
3. Obsługuje tryby wysokiej i niskiej czułości (do metalowych sufitów, metalowych nośników do montażu odbłyśników) oraz pracę ze sterownikiem ściemniacza LED 1-10 V, łatwo dostępna 2-stopniowa lub 3-stopniowa funkcja ściemniania światła.
4. Kompatybilny z modelami Vi-Tech VT-9-151 i VT-9-200 Highbay.

PARAMETRY

Input	Operating Voltage Range	108-305V AC, 50Hz/60Hz
	DC Input Voltage	N/A
	Rated Voltage	100/277V AC, 50Hz/60Hz
	No-load Power	N/A
	Stand-by Power	<1W
Output	Surge Test	L-N: 1kV
	Working Mode	ON/OFF function, 1-10V step dimming
	Type of Load	Inductive or resistive Load
	Load Capacity	100VAC: 4A; 277VAC: 3A
	Current of Load	N/A
Dim Interface	Max. Surge Capacity	50A (50% Ipeak, twidth =500uS, 230Vac full load, cold start);
		80A (50% Ipeak, twidth =200uS, 230Vac, full load, cold start)
	1-10V Dimming	< 50mA (Non-constant source) 10%(1.4-1.6V), 20%(1.9-2.1V), 30%(2.9-3.1V), 50% (4.9-5.1V)
	Synchronous Control	N/A
Sensor Parameters	High Low-level	N/A
	PWM Control	N/A
	Operating Frequency	5.8 GHz ±75 MHz, ISM Band.
	Transmitting power	0.5mW Max.
	Hold time	5s/30s/1min/3min/5min/10min/20min/30min
Others	Stand-by DIM Level	10%/20%/30%/50%
	Stand-by Period	0s/10s/1min/3min/5min/10min/30min/+∞
	Detection Area	25%/50%/75%/100%
	Daylight Sensor	5lux/15lux/30lux/50lux/100lux/150lux/Disable (Ambient light diffusion)
	Mounting Height	15m Max
	Detecting Angle	360°(ceiling mounting)
	Operating Environment	Operating Temperature
Storage Temperature		Temperature:-40 to +80; Humidity:10%-95% (non-condensing)
Others	Wiring	H05RR-F,5*18AWG exposed line length: 810-830mm
	Wiring Color	Sheath: blue, brown, red, purple, gray
	IP Rating	IP65
	Protection Class	Class II
	Installation	Independent
	Dimension	(ΦxH)72*59mm
Lifetime	50,000h @ Ta Full load	

Uwaga

1. "N/A" oznacza, że towar jest niedostępny.
2. Strefa detekcji ruchu zależy od wielkości poruszającego się obiektu i prędkości jego ruchu. Strefę detekcji testuje osoba o wzroście 165 cm przy prędkości kroku 0,5 m/s.

FUNKCJE

1. Funkcja WŁĄCZONO / WYŁĄCZONO (czas czuwania ustawiony na "0").

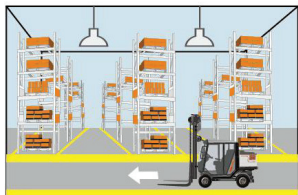

1. Przy wystarczającej ilości światła z otoczenia światło nie będzie WŁĄCZONO, nawet jeśli otrzyma sygnał ruchu.

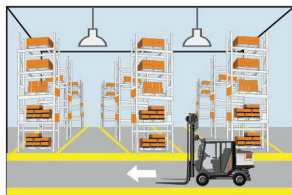

2. Przy niewystarczającym poziomie oświetlenia otoczenia czujnik włącza światło przy wykrywaniu ruchu.

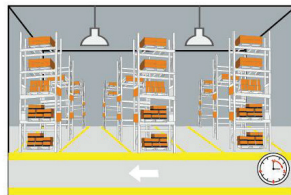

3. Po upływie czasu oczekiwania w przypadku braku dalszego ruchu czujnik wyłącza światło.

- 2) 2-stopniowa funkcja ściemniania (czas czuwania ustawiony na „+ ∞”)

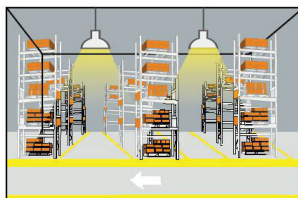

1. Jeżeli nie zostanie wykryty żaden ruch, światło powinno pozostawać włączone przez cały czas przy niskim poziomie oświetlenia.

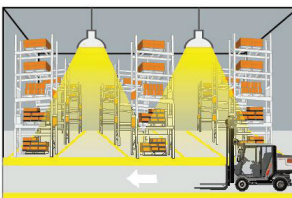

2. Po wykryciu ruchu czujnik włącza światło przy poziomie 100% jasności

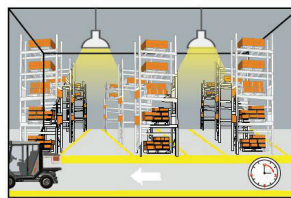

3. Po upływie czasu oczekiwania w przypadku braku ruchu czujnik ściemni poziom światła do aktualnego niskiego poziomu światła.

- 3-stopniowa funkcja ściemniania (czas czuwania ustawiono na „10 sekund / 1 minuta / 3 minuty / 5 minut / 10 minut / 30 minut”)

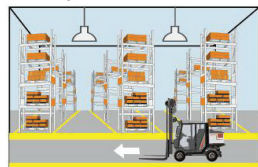

1. Przy wystarczającej ilości światła z otoczenia światło nie zostanie włączone nawet jeśli otrzymano sygnał ruchu.

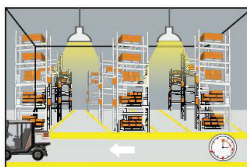

3. Po upływie czasu oczekiwania w przypadku braku ruchu czujnik ściemni poziom światła do niskiego poziomu światła.

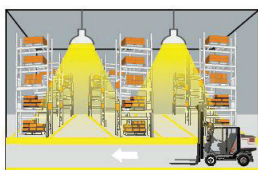

2. Przy niewystarczającym poziomie oświetlenia otoczenia czujnik włącza światło przy wykrywaniu ruchu.

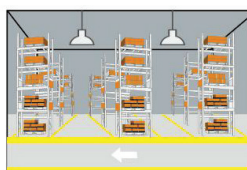

4. Po upływie czasu oczekiwania w przypadku braku dalszego ruchu w strefie wykrywania ruchu czujnik wyłącza światło.

SCHEMAT WYMIARÓW

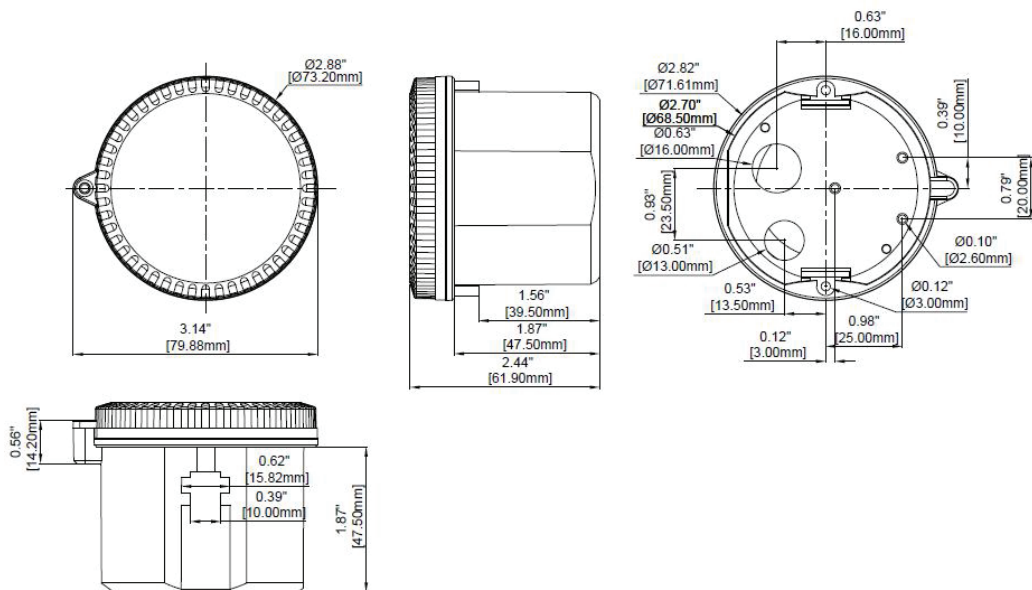

SCHEMAT ELEKTRYCZNY

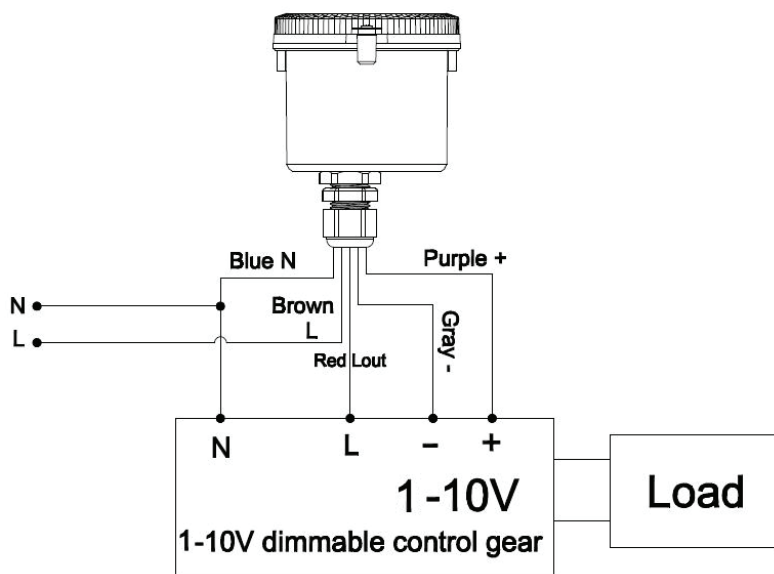

SCHEMAT INSTALACJI

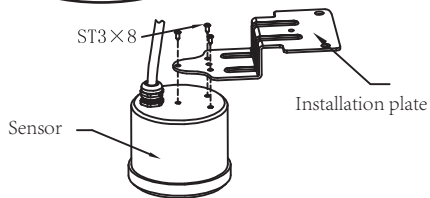
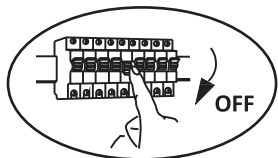

Connect wire box

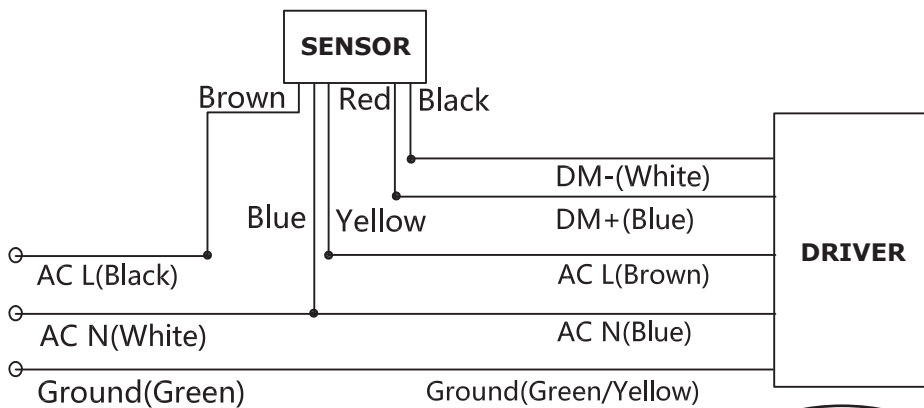
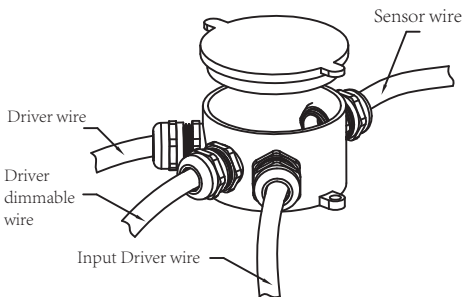
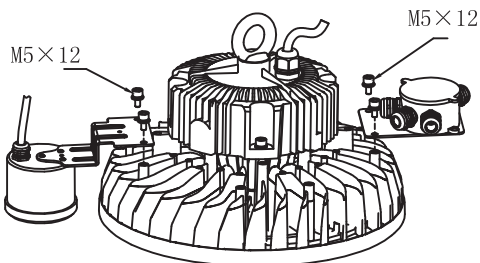
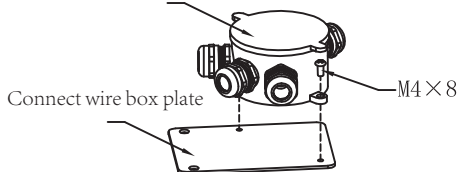

SCHEMAT FUNKCJI

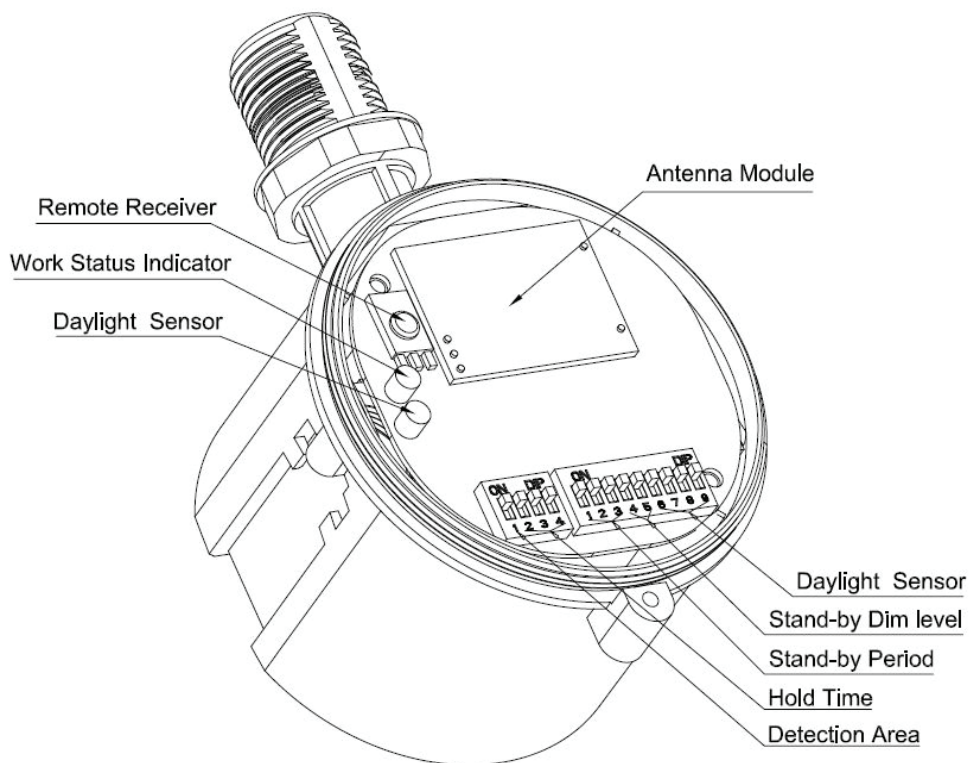

KONTROLA

(HOLD TIME)

	2	3	4	
I	ON	ON	ON	5s
II	-	ON	ON	30s
III	ON	-	ON	1min
IV	-	-	ON	3min
V	ON	ON	-	20min
VI	-	-	-	30min

(STAND-BY PERIOD)

	1	2	3	
I	ON	ON	ON	0s
II	-	ON	ON	1min
III	ON	-	ON	3min
IV	-	-	ON	10min
V	ON	ON	-	30min
VI	-	-	-	+∞

(STAND-BY DIM LEVEL)

	4	5	%	1-10V
I	ON	ON	10%	1.4-1.6V
II	ON	-	20%	1.9-2.1V
III	-	ON	30%	2.9-3.1V
IV		-	50%	4.9-5.1V

(DETECTION AREA)

	1	
I	ON	100%
II	-	50%

(DAYLIGHT SENSOR)

	6	7	8	9	
I	ON	ON	ON	ON	5Lux
II	-	ON	ON	ON	15Lux
III	ON	-	ON	ON	30Lux
IV	-	-	ON	ON	50Lux
V	ON	ON	-	ON	100Lux
VI	ON	ON	ON	-	150Lux
VII	-	-	-	-	Disable*

SCHEMAT MONTAŽU NA SUFICIE

Ceiling mounted
height: 3m
Sensitivity:
100%/75%/50%/25%

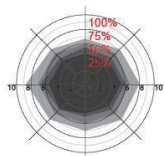

Normal moving
(Speed:1m/s)

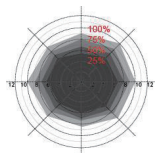

Slow moving
(Speed 0.3m/s)

Ceiling mounted
height: 6m
Sensitivity:
100%/75%/50%/25%

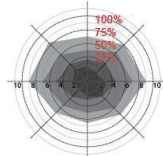

Normal moving
(Speed:1m/s)

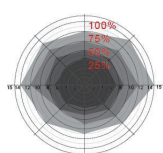

Slow moving
(Speed: 0.3m/s)

Ceiling mounted
height: 9m
Sensitivity:
100%/75%/50%/25%

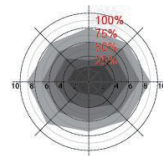

Normal moving
(Speed:1m/s)

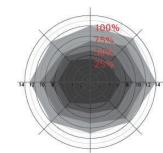

Slow moving
(Speed: 0.3m/s)

Ceiling mounted
height: 12m
Sensitivity:
100%/75%/50%

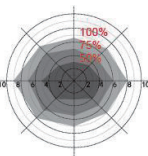

Normal moving
(Speed:1m/s)

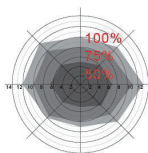

Slow moving
(Speed: 0.3m/s)

Ceiling mounted
height: 15m
Sensitivity:
100%/75%

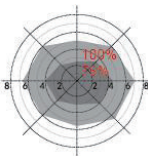

Normal moving
(Speed:1m/s)

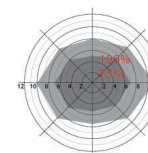

Slow moving
(Speed: 0.3m/s)

*Only 100%/75%/50% detection sensitivity is workable when installed at 10m & 15m mounting height. 25% sensitivity is not able to detect motion signal.

PIRWSZE KROKI

1. Funkcja włączania / wyłączenia / 3-stopniowa funkcja ściemniania:

Po włączeniu czujnik automatycznie włącza oświetlenie ze 100% jasnością. Po 10 sekundach światło się wyłącza. Podczas inicjalizacji czujnik nie może wykrywać ruchu.

2. 2-stopniowa funkcja ściemniania:

Po włączeniu czujnik automatycznie włącza oświetlenie ze 100% jasnością. Po 10 sekundach przyciemnia światło do niskiego poziomu światła (ustawionego przez poziom ściemnienia w trybie czuwania). Podczas inicjalizacji czujnik nie może wykrywać ruchu.

USTAWIENIA FABRYCZNE

Strefa wykrywania: 100%, czas zatrzymania: 5S, czas czuwania: 0s, poziom ściemnienia czuwania: 10%, czujnik światła dziennego: stop.

POWIADOMIENIE O WŁĄCZENIU

- 1) Czujnik musi zostać zamontowany przez profesjonalnego elektryka. Wyłącz zasilanie przed montażem, okablowaniem, zmień ustawienie przełącznika za pomocą dwurzędowych pinów [DIP].
- 2) Czujnik zamontowany jest w plastikowo-szklanym kloszu w celu zmniejszenia czułości. Z każdym wzrostem grubości o 3 mm czułość czujnika zmniejsza się o 20%.
- 3) Wyniki funkcji ściemniania mogą się różnić dla różnych sterowników 1-10 v.
- 4) Próg wrażliwości na światło znajduje się w zakresie nasłonecznionego otoczenia, bez cieni i rozproszonego odbicia światła otoczenia. Poziom oświetlenia otoczenia może być różny w różnych środowiskach, warunkach klimatycznych, klimacie, porze dnia a porze roku.
- 5) Może zajść potrzeba ponownej konfiguracji parametrów czujnika w różnych typach środowiska roboczego.
- 6) Ten czujnik jest przeznaczony wyłącznie do użytku w pomieszczeniach. Brak wodoodporności wpłynie na pracę sprzętu podczas użytkowania na zewnątrz. Wiatr, deszcz i poruszające się obiekty prowadzą do niepotrzebnej aktywacji.
- 7) Odległość między dowolnymi czujnikami indukcyjnymi musi być większa niż 3 m.
- 8) Nie umieszczaj czujnika w pobliżu obiektów o dużej gęstości, takich jak metal, szkło, betonowe ściany, ponieważ może to spowodować niepotrzebne zadziałanie czujnika. Gdy czujnik jest zamontowany w metalowej lampie, metalowych powierzchni odbijających światło lub w szczelnie zamkniętej przestrzeni, mikrofałe będą odbijane wielokrotnie i spowodują niepotrzebną aktywację. Zmniejsz czułość lub skontaktuj się z producentem w celu uzyskania pomocy technicznej.
- 9) Upewnij się, że wokół czujnika nie ma żadnych sygnałów pasożytniczych ruchu, takich jak wentylator, napęd DC, rura kanalizacyjna, wylot powietrza itp., jakie mogą generować niepotrzebną aktywację czujnika.
- 10) Radzimy zrobić 5 próbek przed masowym zastosowaniem czujnika w nowym projekcie oświetleniowym.
- 11) Ze względu na ciągłe doskonalenie treść niniejszej instrukcji może ulec zmianie bez powiadomienia.

INSTRUCȚIUNI DE INSTALARE HIGHBAY SENSOR



5 YEARS
WARRANTY*

INTRODUCERE, GARANȚIA

Vă mulțumim că ați ales și v-ați cumpărat acest produs de V-TAC. V-TAC vă va fi de un mare folos, utilizându-l în modul cel mai potrivit posibil. Vă rugăm să citiți aceste instrucțiuni cu atenție, înainte să începeți instalarea, și păstrați-le pentru că s-ar putea să fie necesar să le recitiți. Dacă aveți și alte întrebări, luați legătură cu dealer-ul nostru sau cu comerciantul de la care v-ați achiziționat produsul. Aceștia sunt bine instruiți și întotdeauna sunt disponibili să vă servească în modul cel mai bun posibil. Garanția este valabilă pe un termen de 5 ani din data achiziționării produsului. Garanția însă nu se aplică cu privire la daunele cauzate de instalare incorectă sau care rezultă din uzura anormală de utilizare. Societatea nu acordă garanție pentru daune produse pe suprafețe, indiferent de tipul acestora, care se datorează îndepărtării sau montării incorecte a produsului.

ATENȚIE

1. Vă rugăm să citiți aceste instrucțiuni și deconectați sursa de alimentare înainte de a începe instalarea.
2. Instalarea se va realiza numai de către un electrician autorizat.



Acest marcaj arată că acest produs nu trebuie aruncat împreună cu deșeurile menajere.



Atenție, există risc de șoc electric.

CARACTERISTICILE PRODUSULUI

1. Tensiunea de alimentare este de 100/277V AC, 50/60Hz
2. Înălțimea de montare a antenei cu microunde va fi de cel mult 15 m, fiind potrivită pentru instalațiile din majoritatea depozitelor.
3. Sunt disponibile regimuri de mare și mică sensibilitate (pentru tavane din metal, pentru un mediu de montare metalic reflectorizant) și funcționează cu driver Led de 1-10V, pentru întunecare, ajungându-se ușor la o funcție de întunecare de 2 sau 3 trepte.
4. Produsul este compatibil cu modelele „Highbay” ale V-Tac VT-9-151 și VT-9-200.

PARAMETRII

Input	Operating Voltage Range	108-305V AC, 50Hz/60Hz
	DC Input Voltage	N/A
	Rated Voltage	100/277V AC, 50Hz/60Hz
	No-load Power	N/A
	Stand-by Power	<1W
Output	Surge Test	L-N: 1kV
	Working Mode	ON/OFF function, 1-10V step dimming
	Type of Load	Inductive or resistive Load
	Load Capacity	100VAC: 4A; 277VAC: 3A
	Current of Load	N/A
Dim Interface	Max. Surge Capacity	50A (50% I _{peak} , t _{width} =500uS, 230Vac full load, cold start);
		80A (50% I _{peak} , t _{width} =200uS, 230Vac, full load, cold start)
		< 50mA (Non-constant source)
	1-10V Dimming	10%(1.4-1.6V), 20%(1.9-2.1V), 30%(2.9-3.1V), 50% (4.9-5.1V)
	Synchronous Control	N/A
Sensor Parameters	High Low-level	N/A
	PWM Control	N/A
	Operating Frequency	5.8 GHz ±75 MHz, ISM Band.
	Transmitting power	0.5mW Max.
	Hold time	5s/30s/1min/3min/5min/10min/20min/30min
Others	Stand-by DIM Level	10%/20%/30%/50%
	Stand-by Period	0s/10s/1min/3min/5min/10min/30min/+∞
	Detection Area	25%/50%/75%/100%
	Daylight Sensor	5lux/15lux/30lux/50lux/100lux/150lux/Disable (Ambient light diffusion)
	Mounting Height	15m Max
	Detecting Angle	360°(ceiling mounting)
	Operating Environment	Operating Temperature
Storage Temperature		Temperature:-40 to +80; Humidity:10%-95% (non-condensing)
Others	Wiring	H05RR-F,5*18AWG exposed line length: 810-830mm
	Wiring Color	Sheath: blue, brown, red, purple, gray
	IP Rating	IP65
	Protection Class	Class II
	Installation	Independent
	Dimension	(ΦxH)72*59mm
Lifetime	50,000h @ Ta Full load	

Observație

1. "N/A" înseamnă - indisponibil.
2. Zona de detectare depinde de volumul obiectului care se mișcă și de viteza de mișcare. Zona de detectare se poate încerca dacă o persoană, cu o înălțime de 165 cm se mișcă cu o viteză de 0.5 m/s.

FUNCȚIILE

1. Funcția CONECTARE/DECONNECTARE (pentru perioada de staționare apăsați pe "0")

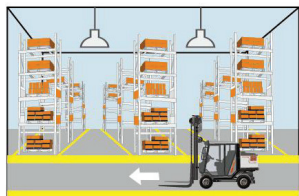

1. Funcția CONECTARE/DECONNECTARE (pentru perioada de staționare apăsați pe "0")

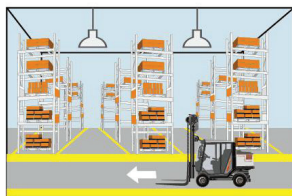

2. Dacă lumina din mediul ambiant este suficientă, senzorul va conecta lumina dispozitivului numai dacă a detectat vreo mișcare.

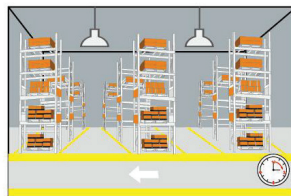

3. După expirarea timpului de așteptare, senzorul va conecta lumina când nu a fost detectată nicio mișcare.

- 2) Funcția de 2-trepte pentru întunecare (perioada de staționare este reglată pentru "+∞")

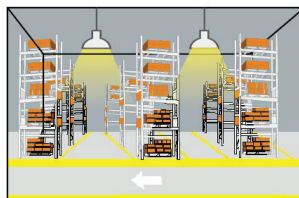

1. Dacă nu s-a detectat nicio mișcare, lumina va rămâne conectată tot timpul, la un nivel scăzut de iluminat.

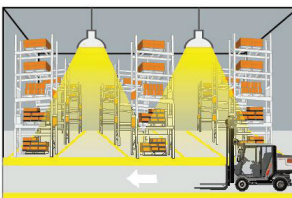

2. Dacă se detectează mișcare, senzorul va conecta lumina cu o luminozitate de 100%.

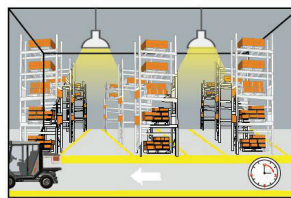

3. După expirarea timpului de așteptare, senzorul va reduce lumina la un nivel scăzut dacă nu s-a detectat nicio mișcare.

- 3) Funcția de întunecare de 3-trepte (perioada de staționare este reglată pentru "10 secunde / 1 minut / 3 minute / 5 minute / 10 minute / 30 minute")

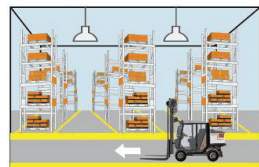

1. Dacă lumina din mediul ambiant este suficientă, lumina dispozitivului nu se va conecta, chiar dacă a fost sesizat semnal de mișcare.

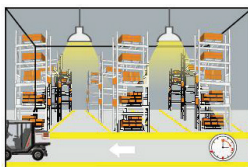

3. După expirarea timpului de staționare, senzorul va întuneca lumina până la nivelul scăzut al acestuia, dacă nu a detectat o nouă mișcare.

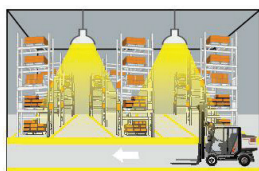

2. Dacă lumina din mediul ambiant este suficientă, senzorul va conecta lumina dacă a sesizat mișcare.

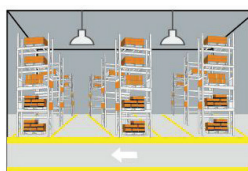

4. După expirarea timpului de așteptare, senzorul va deconecta lumina dacă nu a detectat mișcare în zona de detecție.

DIAGRAMA PRIVIND DIMENSIUNILE



DIAGRAMA PRIVIND CABLAREA



DIAGRAMA PRIVIND INSTALAREA

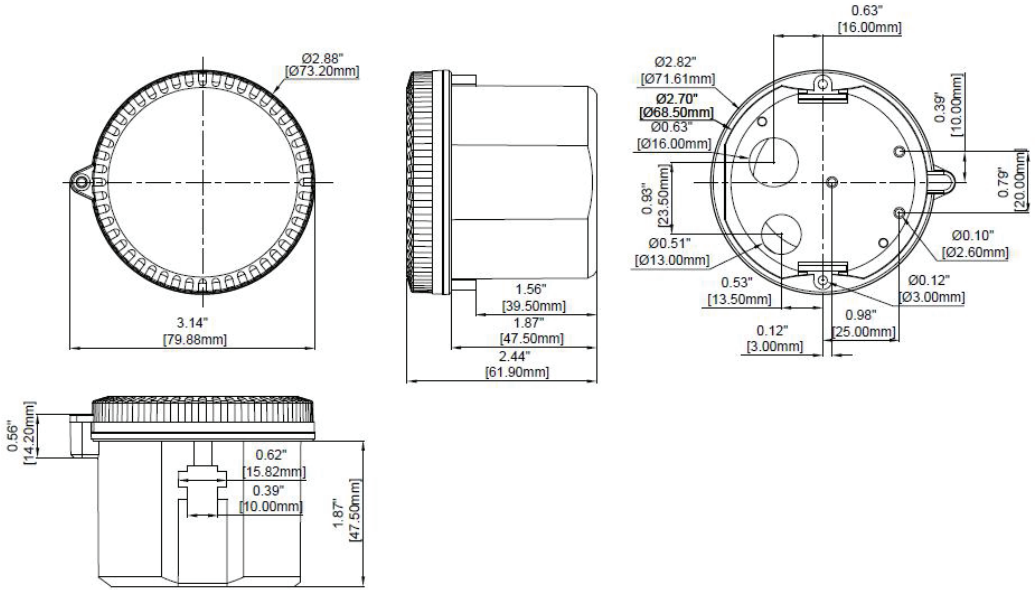

DIAGRAMA PRIVIND FUNCȚIA

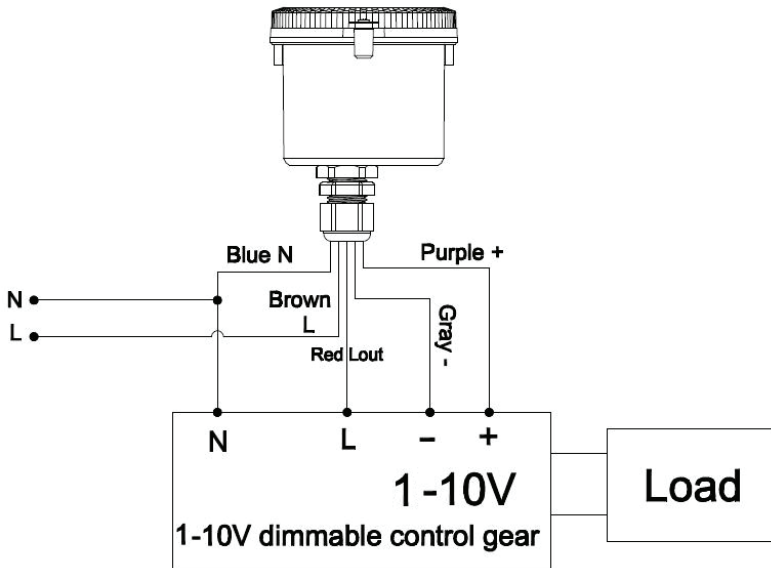

CONTROLUL

(HOLD TIME)

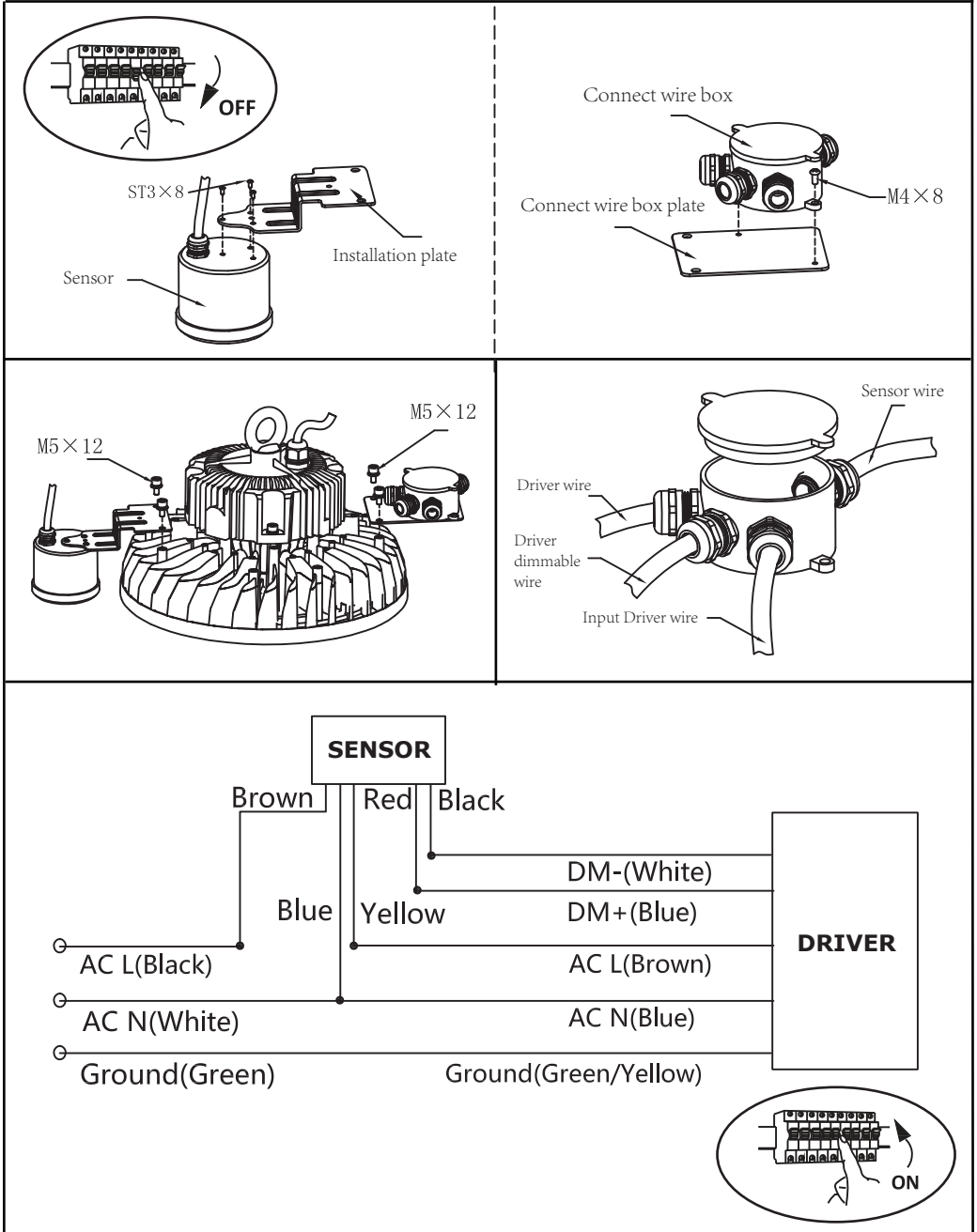
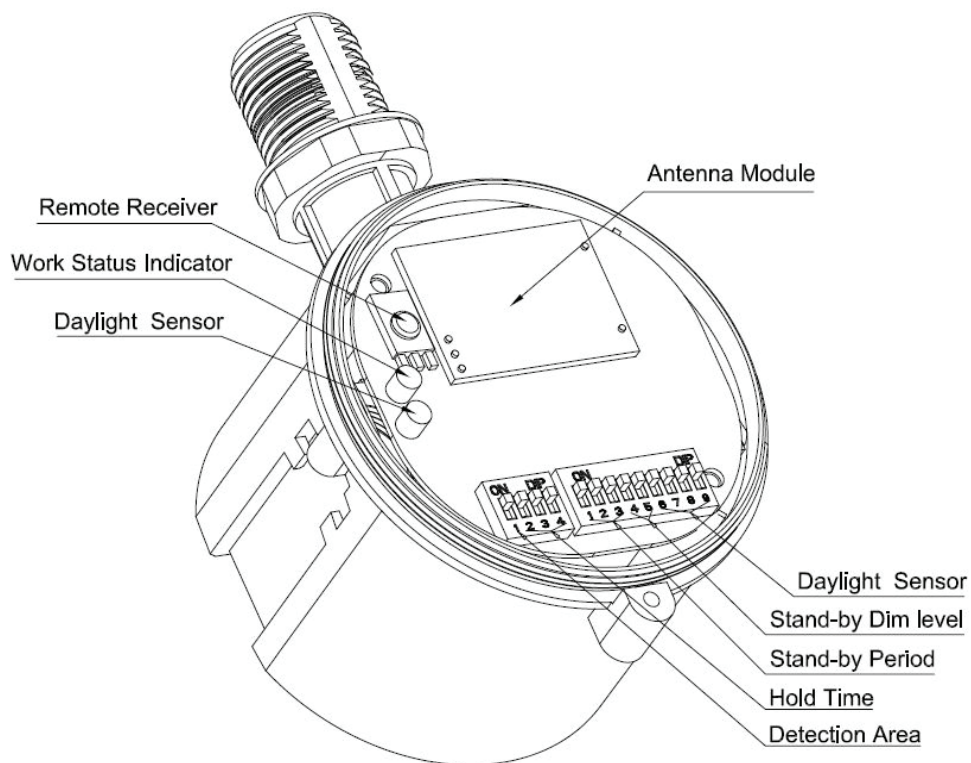
	2	3	4	
I	ON	ON	ON	5s
II	-	ON	ON	30s
III	ON	-	ON	1min
IV	-	-	ON	3min
V	ON	ON	-	20min
VI	-	-	-	30min

(STAND-BY PERIOD)

	1	2	3	
I	ON	ON	ON	0s
II	-	ON	ON	1min
III	ON	-	ON	3min
IV	-	-	ON	10min
V	ON	ON	-	30min
VI	-	-	-	+∞

(STAND-BY DIM LEVEL)

	4	5	%	1-10V
I	ON	ON	10%	1.4-1.6V
II	ON	-	20%	1.9-2.1V
III	-	ON	30%	2.9-3.1V
IV		-	50%	4.9-5.1V

(DETECTION AREA)

	1	
I	ON	100%
II	-	50%

(DAYLIGHT SENSOR)

	6	7	8	9	
I	ON	ON	ON	ON	5Lux
II	-	ON	ON	ON	15Lux
III	ON	-	ON	ON	30Lux
IV	-	-	ON	ON	50Lux
V	ON	ON	-	ON	100Lux
VI	ON	ON	ON	-	150Lux
VII	-	-	-	-	Disable*

DIAGRAMA PRIVIND MONTAJUL PE TAVAN

Ceiling mounted
height: 3m
Sensitivity:
100%/75%/50%/25%

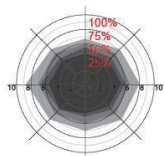

Normal moving
(Speed:1m/s)

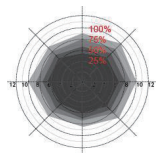

Slow moving
(Speed 0.3m/s)

Ceiling mounted
height: 6m
Sensitivity:
100%/75%/50%/25%

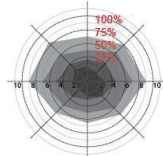

Normal moving
(Speed:1m/s)

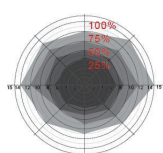

Slow moving
(Speed: 0.3m/s)

Ceiling mounted
height: 9m
Sensitivity:
100%/75%/50%/25%

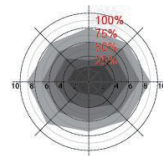

Normal moving
(Speed:1m/s)

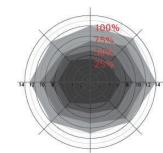

Slow moving
(Speed: 0.3m/s)

Ceiling mounted
height: 12m
Sensitivity:
100%/75%/50%

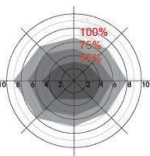

Normal moving
(Speed:1m/s)

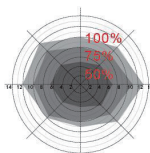

Slow moving
(Speed: 0.3m/s)

Ceiling mounted
height: 15m
Sensitivity:
100%/75%

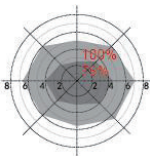

Normal moving
(Speed:1m/s)

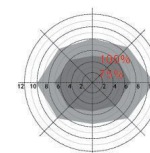

Slow moving
(Speed: 0.3m/s)

*Only 100%/75%/50% detection sensitivity is workable when installed at 10m & 15m mounting height. 25% sensitivity is not able to detect motion signal.

ÎNCEPUTUL

1. Funcția conectare/deconectare /o funcție de întunecare de 3-trepte:

După ce conectați dispozitivul, senzorul va conecta iluminarea în mod automat la o luminozitate de 100%. După 10 secunde, acesta va deconecta lumina. În timpul inițierii funcțiilor, senzorul nu poate detecta apariția vreunei mișcări.

2. Funcția de întunecare de 2-trepte:

În urma conectării, senzorul va conecta iluminarea în mod automat la o luminozitate de 100%. După 10 secunde, acesta va reduce lumina până la un nivel scăzut (indicat de la nivelul de întunecare în regim de așteptare). În timpul inițierii funcțiilor, senzorul nu poate detecta apariția vreunei mișcări

SINTONIZAREA INIȚIALĂ DE LA FABRICĂ

Zona de detectare: 100%, timp de staționare: 5S, perioada de așteptare: 0s, nivelul de întunecare în: 10%, senzorul la lumina zile: Opreire

INFORMAȚII PRIVIND UTILIZAREA

- 1) Senzorul trebuie instalat de către un electrician autorizat. Înainte să începeți instalarea, cablarea și reglarea comutatorului cu bornele situate în două rânduri [DIP], vă rugăm să deconectați dispozitivul de la sursa de alimentare.
- 2) Senzorul care este instalat în abajurul din plastic sau din sticlă, își reduce sensibilitatea. La o creștere a grosimii cu 3 mm, sensibilitatea se va reduce cu 20%.
- 3) Rezultatele în urma conectării funcției de întunecare pot fi diferite pentru diferitele drivere - 1-10v.
- 4) Pragul de sensibilitate este într-un mediu însorit, fără umbre și reflectare difuză a luminii din mediul respectiv. Nivelul de iluminare a mediului poate fi diferit, în funcție de mediul respectiv, de condițiile meteorologice, de clima,, de ora și sezonul.
- 5) Este posibil să fie nevoie de reconfigurarea parametrilor senzorului, în funcție de tipul mediului în care se va instala dispozitivul.
- 6) Acest senzor este destinat numai pentru spații situate la interior. De aceea, dacă îl folosiți la exterior, lucrul acesta va influența rezistența la apă a acestuia. Vântul, ploaia, și obiectele care se mișcă în jur, vor duce la conectarea inutilă a acestuia.
- 7) Distanța dintre senzorii inductivi de orice tip, nu trebuie să fie peste 3 m.
- 8) Nu poziționați senzorul aproape de obiecte cu o mare densitate, cum ar fi de exemplu pereți din metal, sticlă sau beton, pentru că este posibilă o conectare inutilă a acestuia. Dacă instalați senzorul într-o lampă din metal, pe suprafețe metalice reflectorizante sau într-un spațiu închis și strâmt, microundele se vor reflecta de multe ori și vor provoca o conectare inutilă. Vă rugăm să reduceți sensibilitatea sau să luați legătură cu producătorul care răspunde pentru mentenanța tehnică.
- 9) Asigurați-vă că în jurul senzorului nu sunt semnale pentru obiecte în mișcare, cum ar fi de exemplu un ventilator, dispozitiv cu acționare de curent continuu, țevă de canalizație, orificiu de evacuare a aerului, etc., pentru că senzorul poate genera o acționare inutilă.
- 10) Sfatul nostru este să testați 5 mostre, înainte să utilizați senzorul la un proiect nou de iluminat.
- 11) Din cauza îmbunătățirii constante a produsului, conținutul acestor instrucțiuni poate fi înlocuit fără nici un preaviz.

POKYNY PRO INSTALACI HIGHBAY SENSOR



5 YEARS
WARRANTY*

ÚVOD A ZÁRUKA

Děkujeme, že jste si vybrali a koupili výrobek firmy V-TEK (V-TAC). V-TEK (V-TAC) vám nabízí ty nejlepší výrobky. Před zahájením instalace si prosím pečlivě přečtěte tyto pokyny a uschovejte si tento návod pro budoucí použití. Pokud máte další dotazy, obraťte se na našeho prodejce nebo místního obchodního zástupce, od kterého jste výrobek zakoupili. Oni jsou vyškoleni a jsou vám k dispozici pro všechny vaše potřeby. Záruka je platná po dobu 5 let od data zakoupení. Záruka se nevztahuje na škody způsobené nesprávnou instalací nebo atypickým opotřebením. Společnost neposkytuje záruku na poškození na jakémkoli povrchu kvůli neodbornému odstranění a instalaci výrobku.

POZOR

1. Prosím před zahájením instalace si přečtěte tento návod a odpojte napájení.
2. Instalaci smí provést pouze certifikovaný elektrikář



Toto označení znamená, že tento produkt by neměl být likvidován s jiným domácím odpadem.



Pozor, nebezpečí úrazu elektrickým proudem.

VLASTNOSTI PRODUKTU

1. Provozní napětí 100/277V AC, 50/60 Hz
2. Montážní výška mikrovlnné antény je maximálně 15 m, vhodná pro instalaci ve většině skladů.
3. Podporuje režimy s vysokou citlivostí a nízkou citlivostí (pro kovové stropy, montážní prostředí s kovovými reflektory) a práci s ovladačem stmívače 1-10V LED, snadno dosažitelnou dvoustupňovou nebo třístupňovou funkcí stmívání.
4. Kompatibilní s modely V-TAC VT-9-151 a VT-9-200 Highbay

PARAMETRY

Input	Operating Voltage Range	108-305V AC, 50Hz/60Hz
	DC Input Voltage	N/A
	Rated Voltage	100/277V AC, 50Hz/60Hz
	No-load Power	N/A
	Stand-by Power	<1W
Output	Surge Test	L-N: 1kV
	Working Mode	ON/OFF function, 1-10V step dimming
	Type of Load	Inductive or resistive Load
	Load Capacity	100VAC: 4A; 277VAC: 3A
	Current of Load	N/A
Dim Interface	1-10V Dimming	< 50mA (Non-constant source)
		10%(1.4-1.6V), 20%(1.9-2.1V),
		30%(2.9-3.1V), 50% (4.9-5.1V)
	Synchronous Control	N/A
Sensor Parameters	High Low-level	N/A
	PWM Control	N/A
	Operating Frequency	5.8 GHz \pm 75 MHz, ISM Band.
	Transmitting power	0.5mW Max.
	Hold time	5s/30s/1min/3min/5min/10min/20min/30min
	Stand-by DIM Level	10%/20%/30%/50%
	Stand-by Period	0s/10s/1min/3min/5min/10min/30min/+ ∞
	Detection Area	25%/50%/75%/100%
Operating Environment	Daylight Sensor	5lux/15lux/30lux/50lux/100lux/150lux/Disable (Ambient light diffusion)
	Mounting Height	15m Max
	Detecting Angle	360°(ceiling mounting)
	Operating Temperature	-35 to +55
Others	Storage Temperature	Temperature:-40 to +80; Humidity:10%-95% (non-condensing)
	Wiring	H05RR-F,5*18AWG exposed line length: 810-830mm
	Wiring Color	Sheath: blue, brown, red, purple, gray
	IP Rating	IP65
	Protection Class	Class II
	Installation	Independent
	Dimension	(Φ xH)72*59mm
Lifetime	50,000h @ Ta Full load	

Poznámka

1. „N / A“ znamená, že není k dispozici.
2. Zóna detekce závisí na objemu pohybujícího se objektu a rychlosti pohybu. Detekční zóna je testována osobou s výškou 165 cm a rychlostí chůze 0,5 m/s.

FUNKCE

1. Funkce ZAPNUTO / VYPNUTO (doba pohotovosti je nastavena na "0")

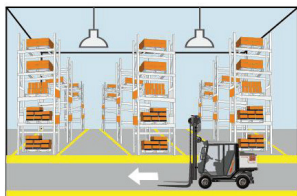

1. Při dostatečném okolním světle se světlo nezapne, i když je přítomen pohybový signál.

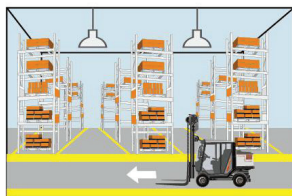

2. V dostatečném okolním světle senzor zapne světlo při detekci pohybu

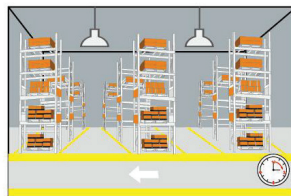

3. Po uplynutí doby zdržení zhasne senzor, pokud není detekován žádný pohyb.

- 2) funkce dvoustupňového stmívání (doba pohotovosti je nastavena na „+ ∞“)

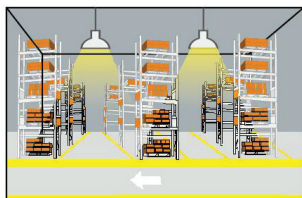

1. Pokud není detekován žádný pohyb, světlo zůstane stále na nízké úrovni.

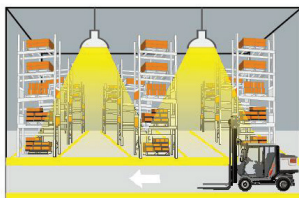

2. Když je detekován pohyb, senzor zapne světlo na 100% jas.

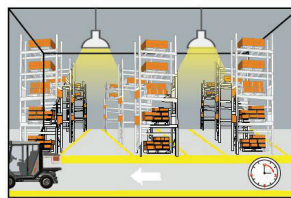

3. Po uplynutí doby zdržení senzor ztlumí světlo při současné nízké úrovni osvětlení, pokud není detekován žádný pohyb.

- 3) funkce třístupňového stmívání (doba pohotovosti je nastavena na „10 s / 1 min / 3 min / 5 min / 10 min / 30 min“)

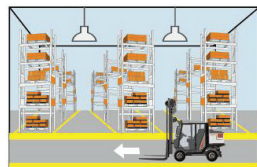

1. Při dostatečném okolním světle se světlo nezapne, i když je přítomen pohybový signál.

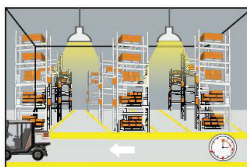

3. Po uplynutí doby zdržení senzor ztlumí světlo při současné nízké úrovni osvětlení, pokud není detekován žádný pohyb.

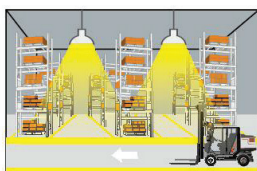

2. V dostatečném okolním světle senzor zapne světlo při detekci pohybu.

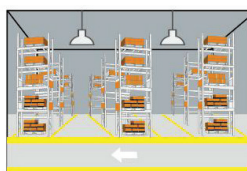

4. Po uplynutí pohotovostního období senzor zhasne světlo, pokud není detekován žádný pohyb v detekční zóně.

SCHÉMA ROZMĚRŮ



SCHÉMA ZAPOJENÍ



SCHÉMA INSTALACE

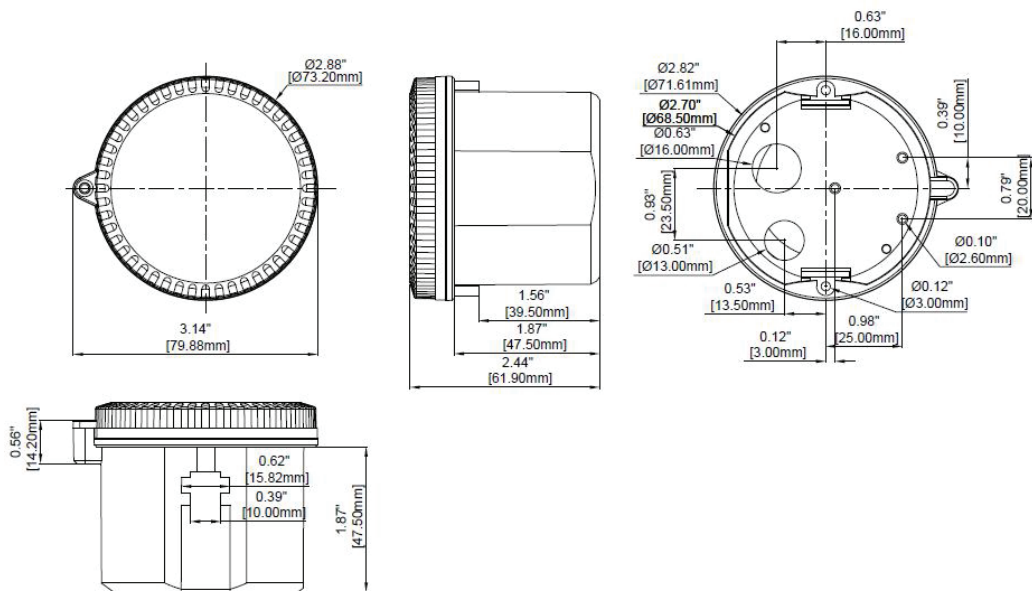

SCHÉMA FUNKCE

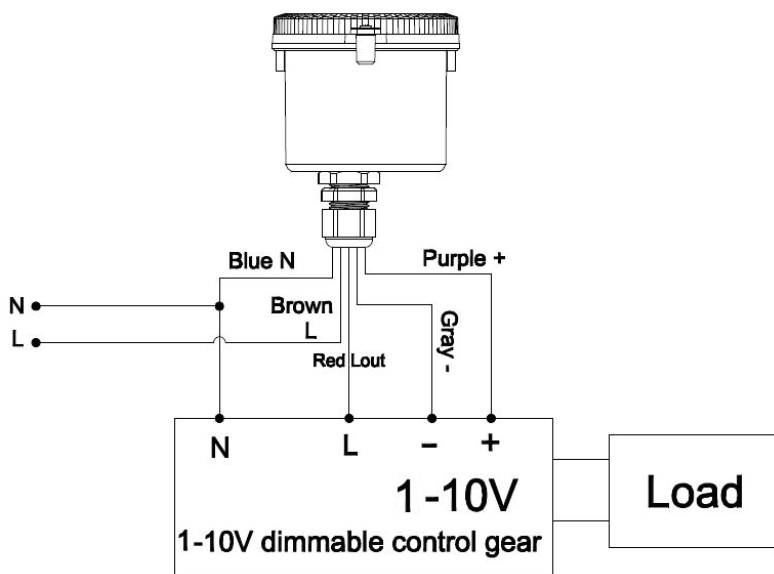

OVLÁDACÍ PRVKY

(HOLD TIME)

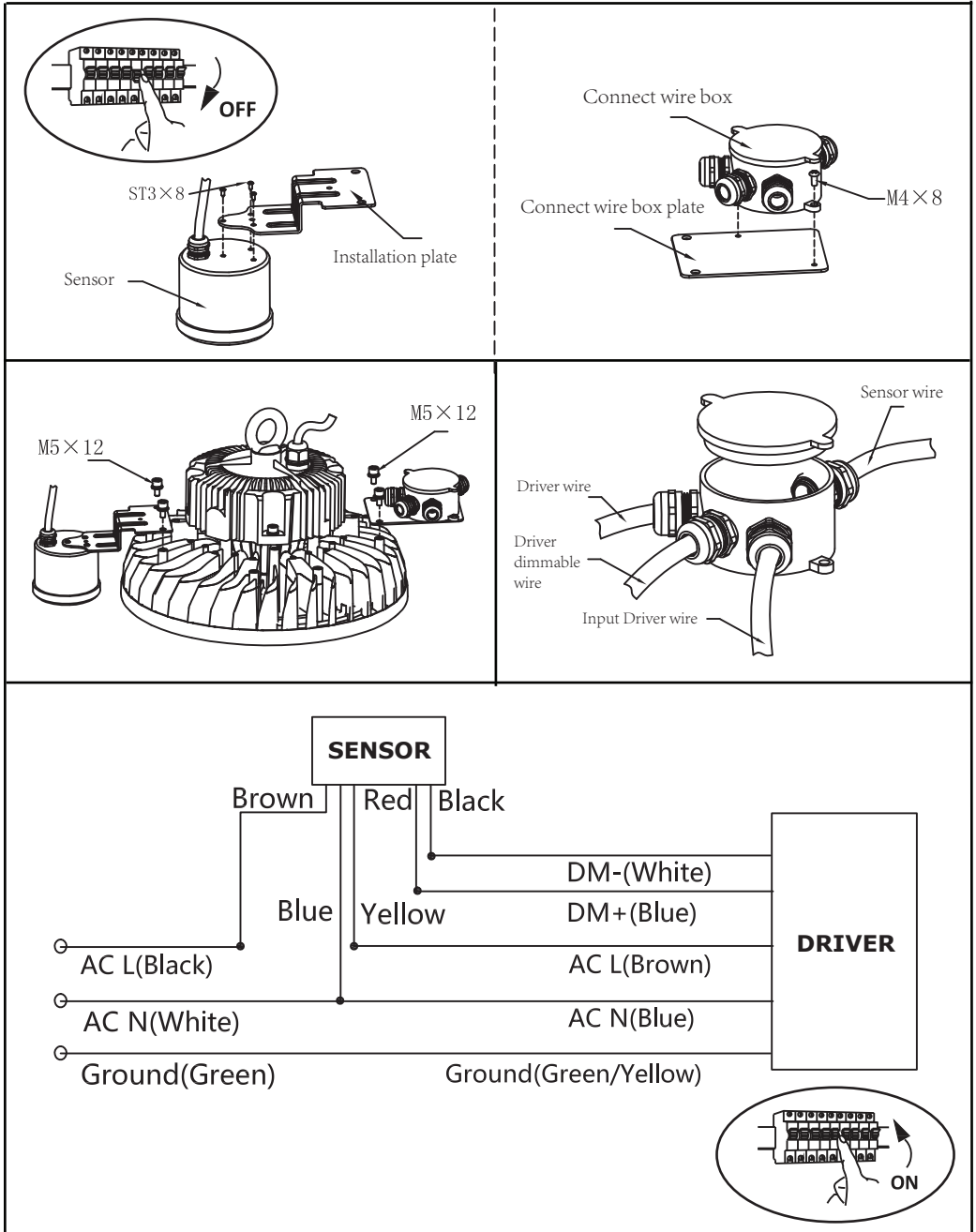
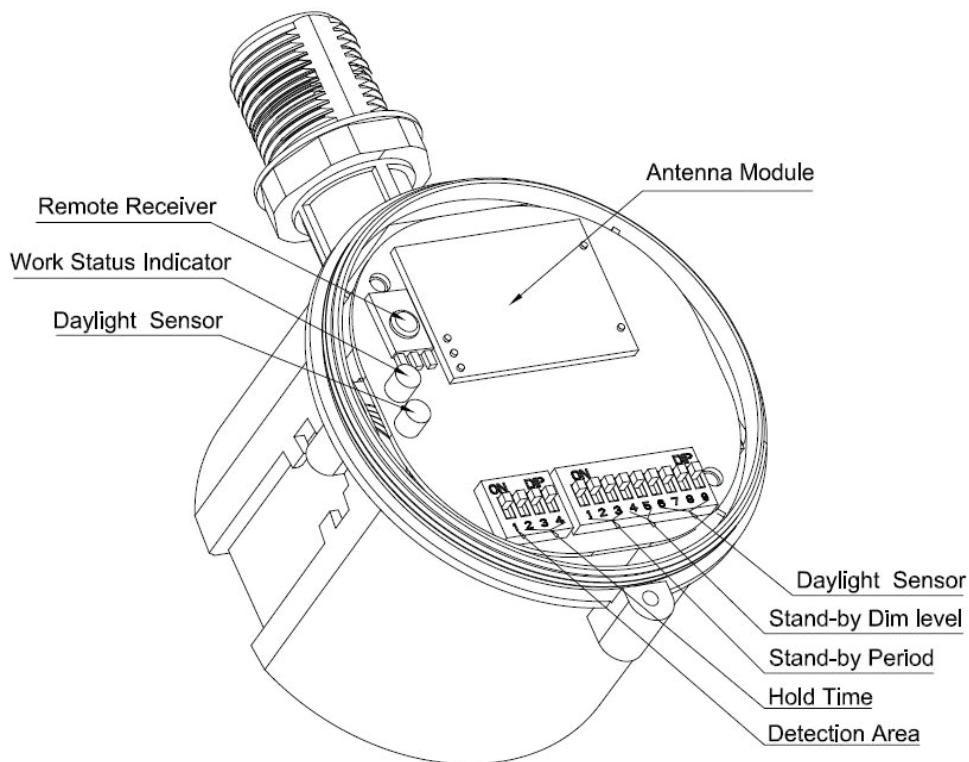
	2	3	4	
I	ON	ON	ON	5s
II	-	ON	ON	30s
III	ON	-	ON	1min
IV	-	-	ON	3min
V	ON	ON	-	20min
VI	-	-	-	30min

(STAND-BY PERIOD)

	1	2	3	
I	ON	ON	ON	0s
II	-	ON	ON	1min
III	ON	-	ON	3min
IV	-	-	ON	10min
V	ON	ON	-	30min
VI	-	-	-	+∞

(STAND-BY DIM LEVEL)

	4	5	%	1-10V
I	ON	ON	10%	1.4-1.6V
II	ON	-	20%	1.9-2.1V
III	-	ON	30%	2.9-3.1V
IV		-	50%	4.9-5.1V

(DETECTION AREA)

	1	
I	ON	100%
II	-	50%

(DAYLIGHT SENSOR)

	6	7	8	9	
I	ON	ON	ON	ON	5Lux
II	-	ON	ON	ON	15Lux
III	ON	-	ON	ON	30Lux
IV	-	-	ON	ON	50Lux
V	ON	ON	-	ON	100Lux
VI	ON	ON	ON	-	150Lux
VII	-	-	-	-	Disable*

SCHÉMA MONTÁŽE STROPU

Ceiling mounted
height: 3m
Sensitivity:
100%/75%/50%/25%

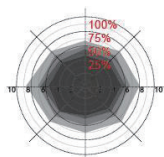

Normal moving
(Speed:1m/s)

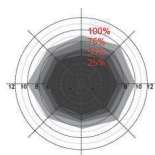

Slow moving
(Speed 0.3m/s)

Ceiling mounted
height: 6m
Sensitivity:
100%/75%/50%/25%

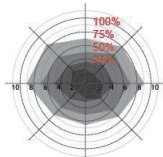

Normal moving
(Speed:1m/s)

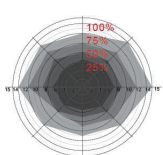

Slow moving
(Speed: 0.3m/s)

Ceiling mounted
height: 9m
Sensitivity:
100%/75%/50%/25%

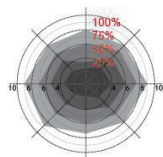

Normal moving
(Speed:1m/s)

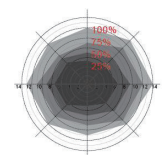

Slow moving
(Speed: 0.3m/s)

Ceiling mounted
height: 12m
Sensitivity:
100%/75%/50%

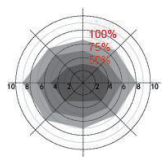

Normal moving
(Speed:1m/s)

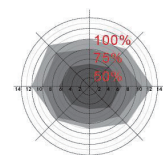

Slow moving
(Speed: 0.3m/s)

Ceiling mounted
height: 15m
Sensitivity:
100%/75%

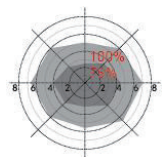

Normal moving
(Speed:1m/s)

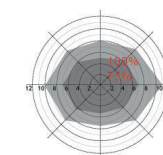

Slow moving
(Speed: 0.3m/s)

*Only 100%/75%/50% detection sensitivity is workable when installed at 10m & 15m mounting height. 25% sensitivity is not able to detect motion signal.

INICIALIZACE

1. Funkce zapnutí / vypnutí / 3-stupňová funkce stmívání:

Po zapnutí senzor automaticky zapne osvětlení při 100% jasů. Po 10 sekundách zhasne světlo. Během inicializace senzor nemůže detekovat pohyb.

2. 2-stupňová funkce stmívání:

Po zapnutí senzor automaticky zapne osvětlení při 100% jasů. Po 10 sekundách ztlumí světlo na nízkou úroveň světla (nastavenou úroveň stmívání v pohotovostním režimu). Během inicializace senzor nemůže detekovat pohyb.

TOVÁRNÍ NASTAVENÍ

etekční zóna: 100%, doba zdržení: 5S, doba pohotovosti: 0s, úroveň tlumení v pohotovostním režimu: 10%, senzor denního světla: vypnuto

UPOZORNĚNÍ PŘI POUŽITÍ

- 1) Senzor musí být instalován odborným elektrikářem. Před instalací, zapojením a změnou nastavení spínače pomocí dvouřadých svorek [DIP] vypněte napájení.
- 2) Senzor, který je nainstalován v plastovém a skleněném stínítku, snižuje citlivost. Pro každé zvýšení tloušťky o 3 mm se citlivost sníží o 20%.
- 3) Výkon stmívání se může lišit u různých ovladačů 1-10V.
- 4) Prahová hodnota citlivosti na světlo je ve slunečném prostředí, bez stínů a difúzního odrazu okolního světla. Úroveň okolního osvětlení se může lišit v různých prostředích, klimatickém počasí, denní době a ročním období.
- 5) Může být nutné znovu nakonfigurovat parametry senzoru v různých typech instalačního prostředí.
- 6) Tento senzor je určen pouze pro vnitřní použití. Bude to mít vliv na vodotěsnost pro venkovní použití. Vítr, déšť a pohybující se objekty kolem vedou k zbytečné aktivaci.
- 7) Vzdálenost mezi indukčními senzory musí být větší než 3 m.
- 8) Neumisťujte senzor do blízkosti předmětů s vysokou hustotou, jako je kov, sklo, betonové zdi, protože může dojít k nesprávnému spuštění. Pokud je senzor nainstalován v kovové lampě, kovovém odrazivém povrchu nebo v těsně uzavřeném prostoru, mikrovlny se opakovaně odrazí a způsobí zbytečnou aktivaci. Snižte citlivost nebo kontaktujte technickou podporu výrobce.
- 9) Ujistěte se, že kolem senzoru nejsou žádné pohyblivé signály, jako je ventilátor, stejnosměrný pohon, kanalizační potrubí, výstup vzduchu atd., Může senzor způsobit zbytečnou aktivaci.
- 10) Doporučujeme vyzkoušet 5 vzorků před hromadnou aplikací senzoru v novém projektu osvětlení.
- 11) Z důvodu neustálého zlepšování se obsah těchto pokynů může změnit bez předchozího upozornění.